KODAK EASYSHARE DX3900 Zoom Digital Camera



User's Guide

Visit Kodak on the World Wide Web at www.kodak.com



Eastman Kodak Company

343 State Street

Rochester, New York 14650

© Eastman Kodak Company, 2001

Kodak, EasyShare, and Ektanar are trademarks of Eastman Kodak Company.

P/N 6B5582

Front View

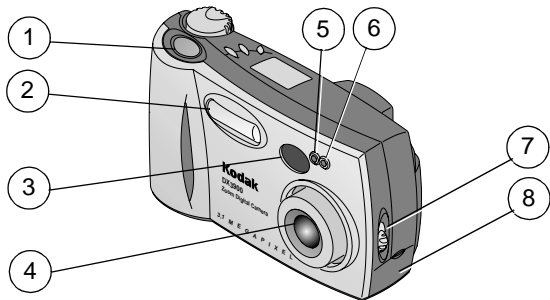

1 Shutter button

2 Flash unit

3 Viewfinder lens

4 Lens (built-in cover
not shown)

5 Light sensor

6 Self Timer light

7 On / Off switch

8 USB connector / Video out
door

Bottom View

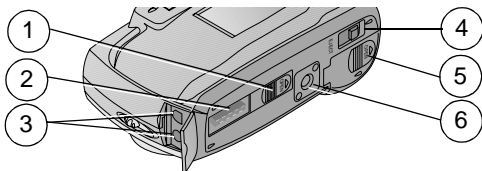

1 Connector door (open)

2 Camera Dock connector

3 USB / Video out connectors

4 Eject button
(Picture Card)

5 Battery door

6 Tripod mount socket

Top/Back View

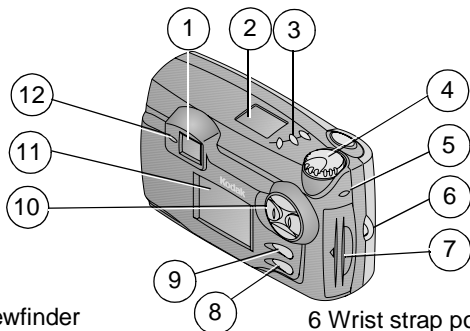

1 Viewfinder

2 Status display

3 Buttons:



Flash



Close-up/Distant



Self Timer

4 Mode dial

5 Picture Card access light

6 Wrist strap post

7 Picture Card door

8 Menu button

9 Select button

10 Four-way arrow button /
Zoom button (W and T)

11 LCD screen

12 Viewfinder light

Mode Dial

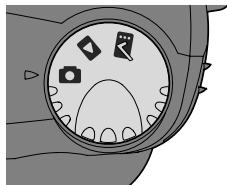

 **Capture**—take pictures

 **Review**—display pictures
on the LCD screen

 **Setup**—customize settings

Status Display

The Status Display is located on the top of the camera. The icons displayed indicate the camera features and settings that are currently active.

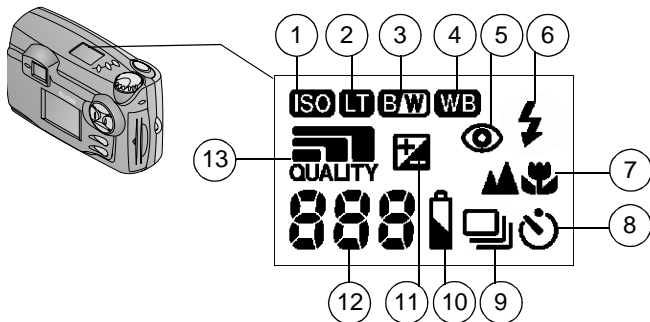

- | | |
|----------------------|--------------------------|
| 1 ISO setting | 8 Self Timer |
| 2 Long-time exposure | 9 Burst |
| 3 Color mode | 10 Battery level |
| 4 White balance | 11 Exposure compensation |
| 5 Red-eye flash | 12 Pictures remaining |
| 6 Flash setting | 13 Quality setting |
| 7 Close-up/Distant | |

Table of Contents

1	Getting Started	1
	What Can I Do With My KODAK EASYSHARE DX3900 Zoom Digital Camera?.....	1
	What Can I Do With My Digital Pictures?	1
	Camera Package Contents	2
	Attaching the Wrist Strap	2
	Loading the Batteries	3
	Inserting a Picture Card	4
	Turning the Camera On and Off	5
	Checking the Batteries	6
	Automatic Powerdown Saves Batteries	6
	Setting the Clock	7
	Mode Dial—Settings and Menus.....	8
	Navigating Through the Menus	11
2	Taking Pictures	13
	Taking a Picture	13
	Viewing and Deleting the Last Picture.....	14
	Previewing Your Picture	15
	Shooting a Burst Series of Pictures	16
	Shooting Distant and Close-Up Pictures.....	17
	Using Zoom.....	18
	Using the Flash.....	19
	Putting Yourself in the Picture.....	20

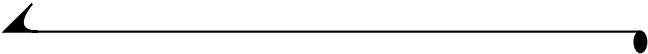

3	Customizing Picture-taking Settings	21
	Setting Exposure Compensation	21
	Setting White Balance	22
	Setting a Color Mode	23
	Setting the Picture Quality.....	24
	Setting Exposure Metering	25
	Setting Picture Sharpness	26
	Setting the ISO Speed.....	27
	Setting the Shutter Speed	28
	Placing the Date on Pictures	29
4	Reviewing Your Pictures	31
	Viewing Pictures in Full Size.....	31
	Viewing Pictures With the Filmstrip	32
	Magnifying Pictures	33
	Deleting Pictures	34
	Protecting Pictures.....	35
	Running a Slide Show.....	36
	Selecting Pictures for Automatic Printing.....	37
	Viewing Picture Information	38
5	Personalizing Your Camera	39
	Selecting a Power Save Setting.....	39
	Setting Digital Zoom Behavior	40
	Adjusting the Camera Sounds	41
	Setting Video Out.....	42
	Selecting a Language	42

Formatting a Picture Card.....	43
Resetting User Settings.....	44
Viewing Camera Information.....	44
6 Installing the Software	45
Install the Software	45
Software Included With Your Camera	47
Computer System Requirements	48
7 Using Pictures on Your Computer	49
Before You Transfer Your Pictures.....	49
Connecting to Your Computer.....	49
Transferring Your Pictures.....	50
Working With Your Pictures	51
Transferring Your Pictures Manually.....	52
Printing Your Pictures	53
8 Using the KODAK EASYSHARE Camera Dock	55
Camera Dock Package Contents	55
Installing the Dock Insert.....	56
Connecting the Camera Dock.....	56
Installing the Battery Pack in the Camera.....	57
Docking the Camera.....	57
Charging the Battery Pack.....	58
Transferring Pictures	59
When Using a Tripod.....	59

9	Troubleshooting Problems	61
	Troubleshooting—Camera	61
	Camera Status and Messages	66
	Troubleshooting—EASYSHARE Camera Dock.....	68
	EASYSHARE Camera Dock Status.....	69
10	Getting Help	71
	Software Help	71
	World Wide Web	71
	Kodak Fax Support.....	71
	Telephone Customer Support.....	72
11	Appendix	75
	Camera Specifications	75
	Camera Dock Specifications	77
	Original Factory Settings—Camera.....	77
	Power Save—Camera Performance	78
	Using Your Batteries.....	79
	Tips, Safety, Maintenance	80
	Camera Accessories	81
	Picture Storage Capacities.....	82
	Locating Pictures on a Picture Card	82
	Picture Card File Naming Conventions	83
	Upgrading Your Software and Firmware.....	83
	Regulatory Information	84

1 Getting Started

What Can I Do With My KODAK EASYSHARE DX3900 Zoom Digital Camera?

Take great pictures with 3.1 Megapixel resolution —in Capture mode, use the default settings for easy point-and-shoot picture-taking, or get the images you want by adjusting the camera settings—ISO levels, white balance, and more.

Review —in Review mode, display your pictures on the LCD screen. Keep only the ones you want, magnify, protect, or run a slide show of all the pictures in your camera.

Set Up —in Setup mode, customize your camera settings.

What Can I Do With My Digital Pictures?

Install the software that is included on the KODAK Picture Software CD*, then:

Transfer—automatically transfer your pictures to your computer.

Share—e-mail your pictures to friends and family.

Print—print to your home printer; make prints yourself at any KODAK Picture Maker; or take your Picture Card to your local photo retailer for professional printing.

Have fun!—add special effects to your pictures, fix red-eye, crop, rotate, and much more.

* MACINTOSH OS X users, see the note on [page 46](#) before installing the KODAK software.

Camera Package Contents

Your camera is packaged with the following items:

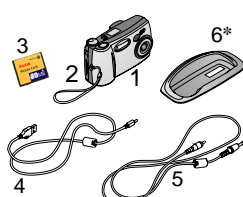
- 
- 1 Camera
 - 2 Wrist strap
 - 3 KODAK Picture Card
 - 4 USB cable
 - 5 Video cable (for viewing pictures on a television)
 - 6 Dock insert*
 - 7 KODAK Lithium Battery, KCRV3, or equivalent** (not shown)
 - 8 User's Guide or User's Guide CD, Quick Start Guide, and Software CD (not shown)

* The Dock insert is used to custom-fit your camera to the KODAK EASYSHARE Camera Dock.

** Your camera may have been packaged with a KODAK EASYSHARE Camera Dock. In that case, you received the KODAK Ni-MH Rechargeable Battery Pack. For details on using the Camera Dock, see [page 55](#).

You may purchase a Camera Dock separately at your KODAK retail dealer or by visiting our Web site at <http://www.kodak.com/go/accessories>.

Attaching the Wrist Strap

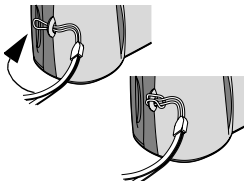

- 1 Thread the short loop of the wrist strap through the wrist strap post.
- 2 Thread the long end of the wrist strap through the short loop. Pull until secure.

Loading the Batteries

A KODAK Lithium Battery, KCRV3 or 2, AA lithium batteries are included with your camera.*

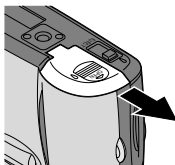

To load the batteries:

- 1 Turn **off** the camera.
- 2 On the bottom of the camera, slide the battery door in the direction of the arrow, then lift to open.
- 3 Insert the batteries as shown below.
- 4 Close the battery door.

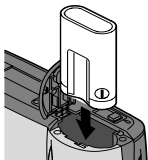

Insert a KCRV3 lithium battery

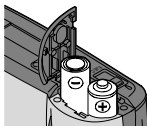

Insert 2 AA batteries

IMPORTANT BATTERY INFORMATION

See [page 79](#) for the types of batteries you can use in your camera.

For acceptable battery life and to make sure your camera operates dependably, do not use alkaline batteries.

* Your camera may have been packaged with a KODAK EASYSHARE Camera Dock. In that case, you received the KODAK Ni-MH Rechargeable Battery Pack. For details on charging and loading the Battery Pack, see [page 57](#).

Inserting a Picture Card

Think of Picture Cards as removable and reusable film, or removable computer memory. Picture Cards, also called memory cards, provide easy picture storage and transfer. See [page 82](#) for Picture Card storage capacities.

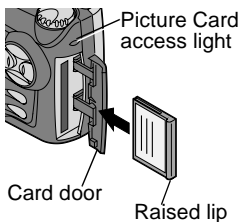

To insert a Picture Card:

- 1 Turn off the camera.
- 2 Slide the Picture Card door in the direction of the arrow on the door, then pivot open.
- 3 Hold the Picture Card so the connection end is pointed into the camera and the raised lip faces the back of the camera.
- 4 Slide the Picture Card into the card slot, then push to seat the connector. Close the door.



CAUTION:

The Picture Card can only be inserted one way into the camera. Do not force the card. It may damage your camera. Do not insert or remove a Picture Card when the Picture Card access light is blinking. Doing so may damage your pictures, Picture Card, or camera.

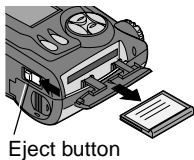

To remove a Picture Card:

- 1 Turn off the camera.
- 2 Open the Picture Card door on the camera.
- 3 On the bottom of the camera, slide the Eject button as illustrated and remove the card.

Use only certified cards that carry the CompactFlash logo



Additional KODAK Picture Cards can be purchased separately on our Web site <http://www.kodak.com/go/accessories>.

Turning the Camera On and Off

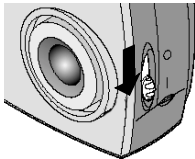

- 1 To turn on the camera, slide the power switch to the On (|) position.

The built-in lens cover opens and the Status Display turns on. If the Mode dial is set to Capture (📷), the lens is extended.

- 2 To turn off the camera, slide the power switch to the Off (●) position.

NOTE: The camera safely completes any Save, Delete, or Copy operations that are in process when the power is turned off.

Built-in Lens Cover

Your camera has a built-in sliding lens cover that protects the lens from dust and scratches. The lens cover opens automatically whenever you turn on the camera, and closes when you turn off the camera.

Checking the Batteries

Check the battery power level in the Status Display before you begin taking pictures. Don't miss an important picture because the camera batteries are low or exhausted.

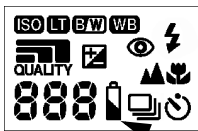

- 1 Turn on the camera.
- 2 Check the battery symbol that appears in the Status Display. If no symbol appears, your battery is fully charged.

Low —batteries soon need to be replaced or recharged.

Exhausted (blinking) —batteries are too weak to power the camera. Replace or recharge the batteries.

For guidelines on battery usage, see [page 79](#).

Automatic Powerdown Saves Batteries

The automatic powerdown feature helps extend battery life by turning off the camera when it has been inactive (no buttons pushed and no pictures taken) for the given time period. For details on the Power Save feature, see [page 39](#).





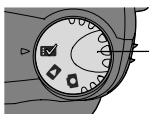

Automatic Powerdown	Activated after	Camera Behavior	To reactivate camera
Power Save off	5 minutes	All camera circuits turn off.	Turn the power switch off, then back on.
Standard		The lens cover remains open, with the lens retracted.	
Power Save on	1 minute		

Setting the Clock

The camera has a built-in clock that maintains the date and time in a 24-hour format. If the battery is removed from the camera for an extended period of time, or is exhausted, you may need to reset the clock.

NOTE: It is important to set the correct date and time if you want to imprint the date on your pictures ([page 29](#)).





- 1 With the camera turned on, turn the Mode dial to Setup .
- 2 Highlight the Date & Time  menu, then press Select.
- 3 Press the / arrow buttons to move through the fields. Press the / arrow buttons to adjust the date and time settings.
- 4 Press Select to accept the changes.



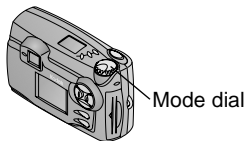

Mode Dial—Settings and Menu

Use the Mode dial to access three ways to use your camera:



Capture  —take pictures and change picture-taking options



Review  —view and work with your pictures on the LCD screen

Setup  —customize your camera functions

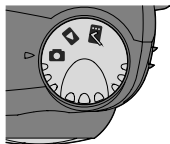
Capture Menu



To access the Capture mode menus:

- 1 Turn the Mode dial to Capture .
- 2 Press the Menu button.
- 3 Use the / arrow buttons to scroll through the menus and submenus.
- 4 Press the Select button.

Menu



Exposure Compensation
(page 21)



White Balance
(page 22)



Color Mode
(page 23)



Quality
(page 24)



Exposure Metering
(page 25)

Menu



Sharpness
(page 26)



ISO Speed
(page 27)



Shutter Speed
(page 28)



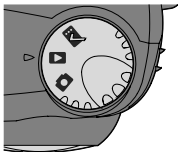

Date and Time Stamp
(page 29)

Review Menus



To access the Review mode menus:

- 1 Turn the Mode dial to Review .
- 2 Press the Menu button.
- 3 Use the / arrow buttons to scroll through the menus and submenus.
- 4 Press the Select button.

Menu



Magnify
(page 33)



Delete
(page 34)



Protect
(page 35)

Menu



Slide Show
(page 36)



Print Order
from Picture Card only
(page 37)



Picture Info
(page 38)

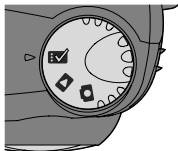

Setup Menus



To access the Setup mode menus:

- 1 Turn the Mode dial to Setup .

The Setup menu screen is displayed on the LCD.

- 2 Use the / arrow buttons to scroll through the menus and submenus.
- 3 Press the Select button.

Menu



Power Save
(page 39)



Digital Zoom
(page 40)



Camera Sounds
(page 41)



Date/Time Set
(page 7)



Video Out
(page 42)

Menu



Language
(page 42)



Format Card
(page 43)



Reset User Settings
(page 44)





About this Camera
(page 44)

Navigating Through the Menus

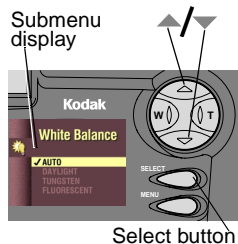
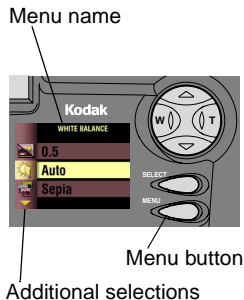
The method of moving through the menus and selecting options is the same in all three camera modes.



To display the menus on the LCD screen:

- In Capture , and Review  modes, press the Menu button.



In Review mode, the menus are displayed on the screen with a picture.

- In Setup  mode, the menus are automatically displayed when you turn the Mode dial to Setup.

The name of the selected menu is displayed at the top of the screen.

An arrow on the screen indicates additional selections.

To navigate and select the menus and options:

- 1 Use the / arrow buttons to scroll through the menus and submenu options.
- 2 Press the Select button to display the submenu for the highlighted menu and to accept a highlighted submenu option.
- 3 In Capture and Review modes, press the Menu button to turn off the menus.

2 Taking Pictures

Before you take pictures, make sure there is a Picture Card in the camera, the Mode dial is turned to Capture , and the camera is on.

Taking a Picture

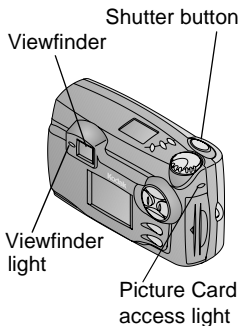

- 1 Center the subject in the viewfinder or use Preview ([page 15](#)).
- 2 Press the Shutter button half-way to lock in the auto-focus and exposure.
The viewfinder light glows green.
- 3 Press the Shutter button completely down to take the picture.

The green Picture Card access light flashes.

In the Status Display, the frame counter blinks and displays the number of pictures remaining. This number can change depending on resolution and Picture Card capacity.

The Automatic QuickView feature displays the picture in the LCD screen ([page 14](#)).

Viewing and Deleting the Last Picture

When you take a picture, Automatic QuickView displays the picture on the LCD screen for several seconds. While the picture is displayed, you can decide to keep it or delete it.

This feature is ideal for verifying picture information.



Press to delete

- 1 Take a picture.

It immediately appears in the LCD screen with the Delete icon and the appropriate picture status icons.

- 2 To delete the picture while it is displayed, press the ▼ arrow button.

The Delete Picture screen appears.

- 3 Highlight Yes, then press Select.

Previewing Your Picture

If you want to see what a picture looks like before it is taken, you can preview a live image on the LCD screen. With Preview activated, use the LCD instead of the viewfinder to frame your picture.

NOTE: Preview is required when you are using digital zooming ([page 18](#)).

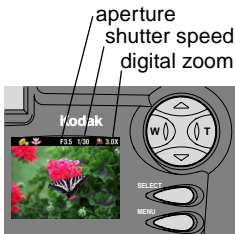

- 1 Press the Select button.
The LCD displays a live image and icons for the activated camera settings.
- 2 Center the subject on the LCD.
- 3 Press the Shutter button half-way to lock the auto-focus and exposure.
The current aperture value and shutter speed are displayed .
- 4 Press the Shutter button completely down to take the picture.

IMPORTANT: *Preview quickly consumes battery power. The flash may also take slightly longer to charge when you use Preview.*



Shooting a Burst Series of Pictures

The Burst feature allows you to take up to 8 pictures in quick succession. When you shoot with the Burst feature, the Flash and the Self Timer features are disabled. Burst is available in the Picture Quality menu (page 24).

NOTE: Burst is ideal for taking pictures of sporting events or for recording moving objects.

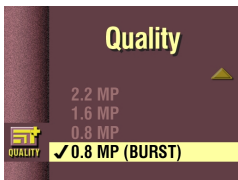
Turn On Burst



- 1 Turn the Mode dial to Capture  and press Menu.
- 2 Highlight the Quality menu , then press Select.
- 3 Highlight the 0.8 MP (Burst) setting.
- 4 Press Select to return to the Menu screen.
- 5 Press Menu to exit the Menu screen.



NOTE: When you turn off the camera, the 0.8 MP (Burst) setting reverts to 0.8 MP; this is unlike the other Quality settings, which remain.

Take a Burst Series of Pictures

- 1 Press the Shutter button half-way to lock the auto-focus and exposure for all the pictures in the sequence.
- 2 Press and hold the Shutter button all the way down to take the pictures.
The camera takes 8 pictures in quick succession while the Shutter button is held down. It stops taking pictures when the Shutter button is released.



Shooting Distant and Close-Up Pictures



Use the Close-Up/Distant /  button to take pictures of scenes that are either very close or very far away.



To choose the setting:

- 1 Set the Mode dial to Capture .
- 2 Press the Close-Up/Distant /  button repeatedly until the appropriate icon appears in the Status Display on top of the camera.
- 3 Press the Shutter button half-way to lock the auto-focus and exposure.
- 4 Press the Shutter button all the way down to take the picture.

Close-Up Pictures

Use the Close-Up setting  to gain sharpness and detail in pictures at close range. When the Close-Up setting is selected, Preview is turned on and the camera automatically sets the focus distance depending on the zoom position:

Zoom position	Close-Up focus distance
Wide Angle	2.8 to 27.6 inches (0.07 to 0.7 m)
Telephoto	9.8 to 27.6 inches (0.25 to 0.7 m)

Distant Pictures

Use the Distant setting  to gain maximum sharpness of far away scenes. With this setting, the camera uses a fixed, infinite focus.

Using Zoom

Your camera offers optical and digital zoom features. Use optical zoom to get up to two times closer (2X) to your subject. Then, to get even closer, use digital zoom for an additional 3X.

In optical zoom, the camera lens extends or retracts as you push the zoom buttons. When you turn on the camera, the lens extends toward the W position. Digital zoom is accomplished with camera image processing; the lens does not move. Preview is required for digital zoom.

Using Optical Zoom

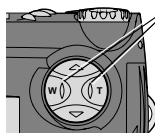

- 1 Set the Mode dial to Capture .
- 2 **Activate optical zoom.** Push T (Telephoto) on the 4-way arrow button to get closer to your subject. Push W (Wide Angle) to get farther away.
- 3 Press the Shutter button all the way down to take the picture.

Using Digital Zoom

To get even closer, **activate digital zoom.**

- 1 Set the Mode dial to Capture  and press Select to turn on Preview.
- 2 Push Telephoto (T) on the 4-way arrow button to its farthest position, the limit of optical zoom. Release the button, then press it again towards T.

See [page 40](#) for different digital zoom options.

The LCD screen displays the zoomed image and the magnification level as it changes.

- 3 Press the Shutter button all the way down to take the picture.

NOTE: You may notice a decrease in printed image quality when using digital zoom. Digital zoom is automatically turned off when the camera state changes (turn off Preview, move the Mode dial, turn off the camera, or when the camera automatically powers off).

Using the Flash

When you take pictures at night, indoors, or outdoors in heavy shadows, your pictures may need flash. The camera flash is effective at the following distances, depending on your zoom position.

Zoom position (at ISO 140)	Effective flash—distance from subject
Wide Angle	1.6 to 10.5 feet (0.5 to 3.2 m)
Telephoto	1.6 to 7.5 feet (0.5 to 2.3 m)

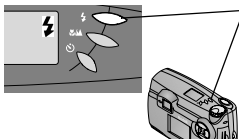

- Press the Flash button  repeatedly to scroll through the flash options.
- The flash icon that is displayed in the Status Display is the active option.
- The flash setting remains unless Reset User Settings is set to Yes (see [page 44](#)).

Auto Flash (no icon)—flash fires when the lighting conditions require it.



Fill—flash fires every time you take a picture, regardless of the lighting conditions.



Off—flash never fires.



Red-eye—flash fires once so the subject's eyes become accustomed to the flash, then fires again when the picture is taken. Ideal for pictures of people.

NOTE: When you are shooting in low-light conditions with the flash turned off, the camera uses slow shutter speeds. Take care to avoid camera shake. Use a tripod or place the camera on a steady surface.

Putting Yourself in the Picture

The Self Timer creates a 10-second delay between the time you press the Shutter button and the time the picture is taken. This setting is ideal when you want to include yourself in the picture.



- 1 Press the Self Timer  button.
To cancel the Self Timer, press the Self Timer button again.



- 2 Place the camera on a flat, steady surface or use a tripod.
- 3 Compose the picture, then press the Shutter button.

The Self Timer light, located on the front of the camera, turns on for 8-seconds, then blinks for 2 additional seconds before the picture is taken.

The Self Timer is turned off when you turn off the camera or change the position of the Mode dial.





3 Customizing Picture-taking Settings

Use Capture  on the Mode dial to customize your picture-taking settings.

Setting Exposure Compensation

Use the Exposure Compensation feature to control how much light is allowed into the camera. You can adjust the exposure by plus or minus 2 stops in 1/2-stop increments.

NOTE: This setting is ideal for controlling scenes in which the light source is behind the subject (backlit), or for correcting pictures that are too light or too dark.

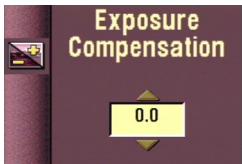

- 1 Turn the Mode dial to Capture  and press Menu.
- 2 Highlight the Exposure Compensation menu , then press Select.
- 3 Use the / arrows to select the Exposure Compensation setting you want to use.
 - If your pictures are too light, decrease (-) the exposure compensation value.
 - If your pictures are too dark, increase (+) the exposure compensation value.
- 4 Press Select to accept the change and return to the Menu screen.
- 5 Press Menu to exit the Menu screen.



This setting remains until you change it unless Reset User Settings is set to Yes (see [page 44](#)).

Setting White Balance

Whites can look white in daylight, but different under other lighting conditions. Use the White Balance setting to correct for these types of color shifts that result from shooting pictures under different light sources.

- 1 Turn the Mode dial to Capture  and press Menu.
- 2 Highlight the White Balance menu , then press Select.

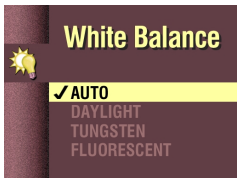

- 3 Highlight the White Balance setting you want to use.

AUTO (default)—automatically corrects the white balance. Ideal for everyday picture taking.

DAYLIGHT—ideal for pictures in natural lighting.

TUNGSTEN—corrects for the orange cast of household light bulbs. Ideal for indoor pictures under this lighting without flash.

FLUORESCENT—corrects for the green cast of fluorescent lighting. Ideal for indoor pictures under this type of lighting without flash.

- 4 Press Select to accept the change and return to the Menu screen.
- 5 Press Menu to exit the Menu screen.

This setting remains until you change it unless Reset User Settings is set to Yes (see [page 44](#)).

Setting a Color Mode

Use the Color Mode setting for controlling color tones and moods. Select color, black and white, or sepia. The camera Preview displays the color setting selected.

- 1 Turn the Mode dial to Capture  and press Menu.
- 2 Highlight the Color Mode menu , then press Select.
- 3 Highlight the Color Mode setting you want to use.

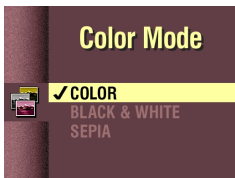

COLOR (default)—for color pictures.

BLACK & WHITE—for black and white pictures.

SEPIA—gives pictures a reddish-brown cast. Ideal for creating an antique look.



When Black & White or Sepia is selected, the **BW** icon appears in the Status Display.

- 4 Press Select to accept the change and return to the Menu screen.
- 5 Press Menu to exit the Menu screen.

This setting remains until you change it unless Reset User Settings is set to Yes (see [page 44](#)).

Setting the Picture Quality

Use the Quality setting to select a picture resolution.

- 1 Turn the Mode dial to Capture  and press Menu.
- 2 Highlight the Quality menu , then press Select.



- 3 Highlight the Quality setting you want to use. 3.1 MP is the highest resolution, 0.8 MP is the lowest. See the table below for details.
- 4 Press Select to accept the change and return to the Menu screen.
- 5 Press Menu to exit the Menu screen.

This setting remains until you change it.

Higher resolutions produce more detailed images and larger file sizes—great for photo-quality prints but take up more space on the Picture Card and may take longer to transmit by e-mail.

Lower resolutions produce less detailed images and smaller file sizes—they look great on-screen, take up less space on the Picture Card, and transmit quickly by e-mail.



See [page 82](#) for how many pictures you can store on different Picture Cards.

Quality Setting Name (in megapixels)	Resolution (in pixels)	File Size (approx.)
3.1 MP (default)	2160 x 1440	960 KB
3.1 MP (High Compression)	2160 x 1440	480 KB
2.2 MP	1800 x 1200	730 KB
1.6 MP	1536 x 1024	550 KB
0.8 MP	1080 x 720	325 KB
0.8 MP (Burst)	1080 x 720	325 KB (each picture in series)

See [page 16](#) for how to use the 0.8 MP (Burst) setting.

Setting Exposure Metering

To ensure proper exposure, your camera features three metering systems for measuring the amount of light entering the camera lens: Multi-Pattern, Center-Weighted, and Center Spot metering.

- 1 Turn the Mode dial to Capture  and press Menu.
- 2 Highlight the Exposure Metering menu , then press Select.
- 3 Highlight the Exposure Metering setting you want to use.



MULTI-PATTERN (default)—evaluates the lighting conditions in the entire scene to give an even picture exposure. Ideal for general picture taking.

CENTER-WEIGHTED—evaluates the lighting conditions of the subject centered in the viewfinder. Ideal for backlit subjects.

CENTER SPOT—similar to Center-Weighted, except the metering is concentrated on a smaller area of the subject centered in the viewfinder. Ideal when an exact exposure of a specific area in the picture is needed.

- 4 Press Select to accept the change and return to the Menu screen.
- 5 Press Menu to exit the Menu screen.

This setting remains until you change it unless Reset User Settings is set to Yes (see [page 44](#)).

Setting Picture Sharpness

Use the Sharpness setting to highlight or blend the edges of the subject in pictures.

1 Turn the Mode dial to Capture  and press Menu.

2 Highlight the Sharpness menu , then press Select.



3 Highlight the Sharpness setting you want to use.

SHARP—increases contrast on the edges of the image. Ideal for improved image clarity, or if you later want to crop or cut out specific areas in the picture.

STANDARD (default)—use when no special effect is needed. Ideal for everyday pictures.

SOFT—softens the edges of the image, creating a “soft focus” effect. Ideal for portraits.



4 Press Select to accept the change and return to the Menu screen.

5 Press Menu to exit the Menu screen.

This setting remains until you change it unless Reset User Settings is set to Yes (see [page 44](#)).

Setting the ISO Speed

The ISO setting controls the camera's sensitivity to light. Use a lower ISO setting in brightly lit scenes, use a higher ISO setting for low-light scenes.

- 1 Turn the Mode dial to Capture  and press Menu.
- 2 Highlight the ISO Speed menu , then press Select.

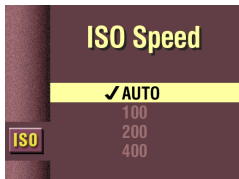

- 3 Highlight the ISO Speed setting you want to use.

AUTO (default)—the camera automatically sets an ISO speed based on scene brightness. Ideal for general picture taking.

ISO 100—ideal for daylight pictures in bright sun, when fine detail is needed. Great for portraits or nature scenes.

ISO 200—ideal for cloudy, overcast days. Great when you need extra speed without sacrificing image quality.

ISO 400—ideal for dusk or night pictures when flash is prohibited; great for pictures at sporting events when you need to stop the action; and excellent for indoor shots, with or without flash.



When any setting except Auto is selected, the  icon appears in the Status Display.

- 4 Press Select to accept the change and return to the Menu screen.
- 5 Press Menu to exit the Menu screen.

This setting remains until you change it unless Reset User Settings is set to Yes (see [page 44](#)).

Setting the Shutter Speed

Use the Auto setting and let the camera automatically set the shutter speed. Or choose a shutter speed from 0.7 to 16 seconds, for longer exposures when taking pictures in low-light conditions, without flash.

- 1 Turn the Mode dial to Capture  and press Menu.
- 2 Highlight the Shutter Speed menu , then press Select.



- 3 Highlight the Shutter Speed setting you want to use.

AUTO (default)—camera sets the shutter speed based on available lighting conditions.

0.7" to 16" (seconds)—use a tripod to avoid camera shake.

*If you select a shutter speed from 0.7 to 16 seconds, the **LT** (Long Time exposure) icon appears in the Status Display.*



- 4 Press Select to accept the change and return to the Menu screen.
- 5 Press Menu to exit the Menu screen.

This setting remains until you change it unless Reset User Settings is set to Yes (see [page 44](#)).

Placing the Date on Pictures

Use the Date & Time Stamp setting to imprint the date, or the date and time, on the lower-right corner of the picture.

NOTE: This setting is ideal for recording when a picture was taken; for example, for a birthday or an insurance claim.

- 1 Make sure the camera clock is set to the correct time (see [page 7](#)).
- 2 Turn the Mode dial to Capture  and press Menu.
- 3 Highlight the Date & Time Stamp menu , then press Select.
- 4 Highlight the Date Stamp option you want to use (yyyy=year, mm=month, dd=day, hh=hour, mm=minute). The camera default is None.
- 5 Press Select to accept the change and return to the Menu screen.
- 6 Press Menu to exit the Menu screen.

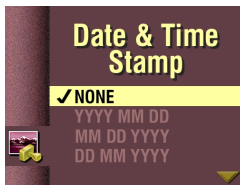

The next time you take a picture, the date stamp is recorded in the lower-right corner of the picture.

This setting remains until you change it unless Reset User Settings is set to Yes (see [page 44](#)).

4 Reviewing Your Pictures

Use the Review setting  on the Mode dial to review and work with the pictures that are stored on the Picture Card in your camera.

You can view each picture stored on the Picture Card in your camera in full LCD screen size, or you can use the Filmstrip feature to view and select from up to three thumbnail-size pictures at one time.

NOTE: This is ideal for sharing pictures on the camera with friends, or for verifying your pictures before you transfer or print them.





Viewing Pictures in Full Size

- 1 Turn the Mode dial to Review .

The last picture taken is displayed in the LCD screen with the frame number and the following icons, if activated: Index Print, Print Order, and Protect.





- 2 Use the 4-way arrow button to scroll through the pictures:

-  forward
-  backward
-  first picture
-  last picture

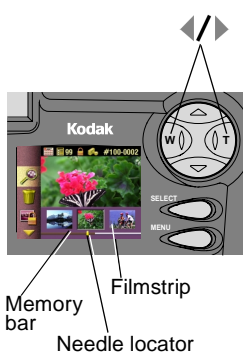
Viewing Pictures With the Filmstrip



- 1 Turn the Mode dial to Review , then press Menu to display the Filmstrip.
- 2 Press the   arrow buttons to scroll through the Filmstrip. To continuously scroll, press and hold an arrow button. For fast scrolling through the memory bar, press Select while holding an arrow button.

When you release the arrow button, the LCD screen is refreshed with the new, current picture.



The dark section of the memory bar represents the part of the card that is full. The needle locator shows the position of the picture on the card.

- 3 Press Menu to exit the Filmstrip.

Magnifying Pictures



Use the Magnify feature to zoom in on specific parts of a picture. With this feature, you can magnify at two or four times the normal magnification level.

NOTE: This feature is ideal for checking detail and verifying sharp focus on your pictures.

- 1 Turn the Mode dial to Review  and press Menu.
- 2 Press an  arrow button to display the picture you want to magnify.
- 3 Highlight the Magnify menu , then press Select.

4 Press Select once to magnify the picture at 2X magnification, or press twice for 4X.

The magnified picture, with magnification level, appears on the LCD screen.

5 Use the   buttons to navigate to different areas of the picture.

6 Press the Select button to exit Magnify.

7 Press Menu to exit the Menu screen.







Press to navigate

Press to magnify

Deleting Pictures

Use the Delete feature to quickly delete one or all pictures from the Picture Card.

NOTE: Delete pictures to free up space on the Picture Card.

- 1 Turn the Mode dial to Review  and press Menu.
- 2 Press an /  arrow button to display the picture you want to delete.
- 3 Highlight the Delete menu , then press Select.

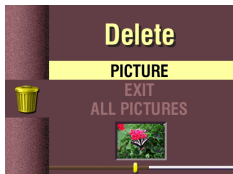

- 4 Highlight the Delete setting you want to use.
 - PICTURE**—deletes the selected picture.
 - EXIT (default)**—returns you to the Main screen.





ALL PICTURES—deletes all the pictures on the Picture Card. Use the filmstrip to review the pictures before deleting.

Protected pictures are not deleted. See [page 35](#) for how to unprotect.

- 5 Press Select.
- 6 Press Menu to exit the Menu screen.

Protecting Pictures

Use the Protect feature to prevent special pictures from being accidentally deleted from the Picture Card.

- 1 Turn the Mode dial to Review  and press Menu.
- 2 Press an  /  arrow button to display the picture you want to protect.
- 3 Highlight the Protect menu , then press Select.



- 4 Press Select to protect the picture.

The Protect icon appears in the LCD screen with the protected picture.

- 5 Press Select again to remove picture protection.
- 6 Press Menu to exit the Menu screen.

Running a Slide Show

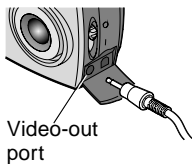

Use the slide show feature to automatically display your pictures on the camera LCD screen at a selectable interval rate. You can also run a slide show on any video device that is equipped with a video input, such as a television, computer monitor, or digital projector. The slide show feature is not available when you have only one picture stored on the Picture Card.

NOTE: The Slide Show feature is ideal for sharing pictures at a social function or at business meetings.



If you are running the slide show on an external video device, plug the video cable in as follows:

- Plug the appropriate end of the video cable (included with your camera) into the video-out port on the camera. Plug the other end into the video-in port on your external device (television, VCR, computer monitor, digital projector).
- Refer to your television or other device user's guide for details on video-in setup.

- 1 Turn the Mode dial to Review  and press Menu.
- 2 Highlight the Slide Show menu , then press Select.







- 3 Press Select to display the Slide Show Interval screen.
- 4 Use the \blacktriangle / \blacktriangledown buttons to select how long each picture is displayed on the LCD screen (5-99 seconds).
- 5 Press Select to start the slide show.
- 6 Press Select again to cancel the Slide Show.

Selecting Pictures for Automatic Printing

Use the Print Order feature to select specific pictures and print quantities to be printed automatically to a KODAK Personal Picture Maker or other direct-print-enabled printer.

NOTE: This feature saves time when printing. When you put the Picture Card into a print order enabled printer, only the images you marked are printed.

- 1 Turn the Mode dial to Review  and press Menu.
- 2 Press an  /  arrow button to display the picture you want to select for printing.
- 3 Highlight the Print Order menu , then press Select.

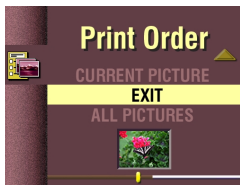

- 4 Highlight the Print Order setting you want to use.

CANCEL PRINT ORDER—cancels the entire print order from the Picture Card.

INDEX PRINT—orders a print containing a thumbnail image of each picture on the Picture Card.

CURRENT PICTURE—orders the currently selected picture.

EXIT—returns you to the Main screen.

ALL PICTURES—selects all the pictures on the Picture Card. The filmstrip appears at the bottom of the LCD screen to remind you that all pictures are affected.



- 5 If you selected Cancel Print Order or Index Print, a screen appears that asks you to confirm your choice. Answer Yes or No.

If you selected Current Picture or All Pictures, the # Copies screen appears. Press an ▲/▼ arrow button to select the number of prints you want (0-99). Zero (0) cancels the order for that picture.

- 6 Press Select.

The Print Order icon appears in the LCD screen with the pictures that are marked for printing.

- 7 Press Select.

- 8 Press Menu to exit the Menu screen.

Viewing Picture Information

The Picture Information feature displays specific data for each picture on the Picture Card in your camera. For example, the information includes the picture number, the date and time the picture was taken, and the settings that were used for the picture.

- 1 Turn the Mode dial to Review  and press Menu.

- 2 Press an ◀/▶ arrow button to display a picture.

- 3 Highlight the Picture Info menu , then press Select.



- 4 Use the ▲/▼ buttons to scroll up and down through the picture information.

The picture information displayed in the LCD screen is view-only.



- 5 Press Select to exit Picture Info.

5 Personalizing Your Camera

Use Setup  on the Mode dial to customize the camera settings according to your personal preferences.

Selecting a Power Save Setting

The Power Save feature is designed to balance battery consumption with camera performance. See [page 78](#) for how the settings affect camera performance.

- 1 Turn the Mode dial to Setup .
- 2 Highlight the Power Save menu , then press Select.

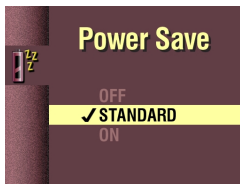

- 3 Highlight the Power Save setting you want to use.

OFF—camera performance has priority over battery consumption. Ideal when battery life is not a primary concern.

STANDARD (default)—battery consumption and camera performance are optimized equally. Ideal for everyday shooting.

ON—battery life has priority over camera performance. Ideal when you have only one battery or one set of batteries available.

- 4 Press Select.

This setting remains until you change it.

Setting Digital Zoom Behavior

Digital zoom provides three times (3X) magnification beyond the optical zoom. You can specify how the digital zoom feature behaves when you push Telephoto (T) on the 4-way arrow button beyond the limit of optical zoom.

See [page 18](#) for how to use digital zoom.

1 Turn the Mode dial to Setup .

2 Highlight the Digital Zoom menu , then press Select.

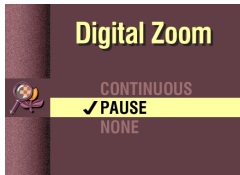

3 Highlight the Digital Zoom setting you want to use.

CONTINUOUS—zooms directly from optical TelePhoto to digital zoom without stopping. Ideal for fast transition from optical to digital zoom.

PAUSE (default)—zoom stops between the limit of optical zoom (2X) and the beginning of digital zoom.

To use the Pause setting, push Telephoto (T) on the 4-way arrow button to its farthest position, the limit of optical zoom. Release the button, then press it again towards T.

NONE—disables digital zoom.

4 Press Select.

This setting remains until you change it.

Adjusting the Camera Sounds

The camera provides sounds (beeps) to let you know when certain functions are being performed. You can set the camera to make sounds for most functions, for selected functions, or to make no sounds at all.

NOTE: Set the Camera Sounds to OFF when taking pictures at events that require a quiet environment, for example, a wedding or a play.

- 1 Turn the Mode dial to Setup .
- 2 Highlight the Camera Sounds menu , then press Select.

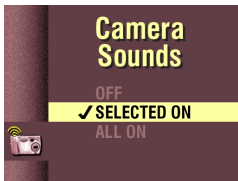



- 3 Highlight the Camera Sounds setting you want to use.
 - OFF**—provides no camera sounds.
 - SELECTED ON (default)**—provides camera sounds only when the Shutter button is pressed or for camera warnings.
 - ALL ON**—provides camera sounds whenever possible, for most functions.

- 4 Press Select.

This setting remains until you change it.

Setting Video Out

The Video Out feature allows you to match the camera video-out signal to the standard applicable in your area.

- 1 Turn the Mode dial to Setup .
- 2 Highlight the Video Out menu , then press Select.
- 3 Highlight the Video Out setting you want to use.
 - NTSC (default)**—standard used in most countries except Europe. The United States and Japan use NTSC.
 - PAL (EUROPE)**—standard used in European countries.

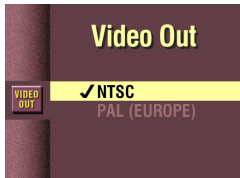



- 4 Press Select.

This setting remains until you change it.

Selecting a Language

The Language feature allows you to display the menus and screen messages in different languages.



NOTE: In certain countries, the language menu is not available. These cameras must be operated only in the language installed at the factory.

- 1 Turn the Mode dial to Setup .
 - 2 Highlight the Language menu , then press Select.
 - 3 Highlight the Language setting you want to use.
 - 4 Press Select.
- This setting remains until you change it.



Formatting a Picture Card

You may need to format a Picture Card if the card becomes corrupted. When this happens, an error message appears on the LCD screen. See [page 67](#) for error messages.

- 1 Turn the Mode dial to Setup .
- 2 Highlight the Format Card menu , then press Select.
- 3 Highlight the Format Card setting you want to use.
 - CONTINUE FORMAT**—erases all the information on the card and formats the Picture Card for use in the camera.
 - CANCEL (default)**—exits without making a change.
- 4 Press Select.

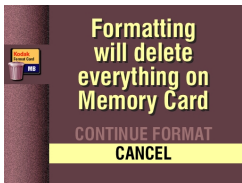



CAUTION:

Formatting erases everything, even protected pictures, from the Picture Card. Removing the Picture Card during formatting may damage the card.

Resetting User Settings

The Reset User Settings feature allows you to return most Capture menu settings to the original factory defaults each time the camera is turned off. See [page 77](#) for a list of the original factory defaults.

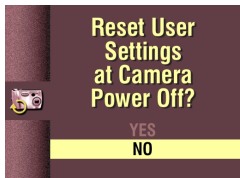

- 1 Turn the Mode dial to Setup .
- 2 Highlight the Reset User Settings menu , then press Select.
- 3 Highlight the Reset setting you want to use.
 - Yes**—every time the camera is turned off, most Capture menu settings are returned to the original factory defaults.
 - No (default)**—when the camera is turned off, your customized settings are retained.
- 4 Press Select.

This setting remains until you change it.



Viewing Camera Information

Use the About feature to find your camera name and model and the firmware version (camera's internal software). This information is especially helpful if you need to call for service on your camera.

- 1 Turn the Mode dial to Setup .
- 2 Highlight the About Camera menu , then press Select.

The information that appears is view-only.
- 3 Press Select.



See [page 83](#) for how to upgrade your camera with the latest firmware.

6 Installing the Software

Make sure that you install the software from the KODAK Picture Software CD before you transfer pictures from your camera to the computer.

MACINTOSH OS X users, see the note on [page 46](#) before installing the software.

Install the Software

- 1 Before you begin, close all software applications running on your computer.
- 2 Place the KODAK Picture Software CD into the CD-ROM drive.
- 3 Install the software:

On a WINDOWS-based computer—usually, the first install window automatically appears. If it does not, choose Run from the Start menu and type the drive letter that contains the CD followed by \setup.exe. For example: `d:\setup.exe`.

On a MACINTOSH computer—click Continue on the install window that automatically appears.

- 4 Follow the on-screen instructions to install the software. If prompted, restart the computer when the installation is complete.

To install all applications on the CD, select Typical when prompted.

To choose the applications you wish to install, select Custom when prompted. See [page 47](#) for a description of the applications that are included on the CD.

NOTE: Take a few minutes to electronically register your camera and software when you are prompted to do so. You must be connected to your Internet service provider to register electronically.

Note to MACINTOSH OS X Users

Do not install KODAK Connection Software or Picture Transfer Software—MACINTOSH OS X ships with an image capture application that provides the functionality of both the KODAK Connection Software and KODAK Picture Transfer Software. These two applications are unnecessary and will not function if installed on MACINTOSH OS X. The MACINTOSH OS X image capture application automatically launches when the camera is connected to the computer with the USB cable or the KODAK EASYSHARE Camera Dock

Optional, install KODAK Picture Software—You may wish to install KODAK Picture Software for picture viewing, editing, and sharing. KODAK Picture Software installs and runs with MACINTOSH OS X in Classic mode. MACINTOSH OS X Classic Mode launches OS 9 and runs the application in that environment. OS 9 launches automatically when KODAK Picture Software is opened.

Software Included With Your Camera

The KODAK Picture Software CD contains the following applications that let you access, transfer, and have fun with your digital pictures. Your CD may contain additional software not described here.

For detailed information on using the applications, refer to the online help supplied with each application.

KODAK Picture Transfer Software

Automatically transfer your pictures from the camera to the computer, and organize and rename your picture files. See [page 50](#) for more information.

KODAK Picture Software

After you have transferred your pictures to your computer, use KODAK Picture Software to:

- View and share your pictures.
- Add special effects, make a custom slide show, fix red-eye, crop and rotate, and much more.
- E-mail your pictures to friends and family.

KODAK Camera Connection Software

KODAK Camera Connection Software displays the camera as a removable drive on your desktop. Access the pictures in your camera as you would the contents of any removable drive to transfer, copy, move, rename, or delete the pictures. For more information, see [Transferring Your Pictures Manually](#) on [page 52](#).

Computer System Requirements

For acceptable picture transfer and editing, we recommend the following minimum requirements:

WINDOWS-Based System Requirements

- Personal computer designed for WINDOWS 98, 98SE, ME, or 2000
- 200 MHz processor
- RAM:
 - 48 MB minimum (96 MB recommended) for WINDOWS 98, 98SE, ME
 - 64 MB minimum (128 MB recommended) for WINDOWS 2000
- 100 MB of available hard disk space
- CD-ROM drive
- Available USB port
- Color monitor with a minimum resolution of 800 x 600 pixels; High Color (16-bit) or True Color (24-bit) recommended

MACINTOSH System Requirements

- PowerPC-based MACINTOSH computer
- MACINTOSH OS 8.6, 9.x, X
- 64 MB of available RAM
- 100 MB of available hard disk space
- CD-ROM drive
- Built-in USB port or CompactFlash card reader
- Color monitor with a minimum resolution of 800 x 600 pixels; thousands or millions of colors recommended

Visit our Web site at <http://www.kodak.com> for information on compatibility with new operating systems as they become available.

7 Using Pictures on Your Computer

Transfer your pictures to your computer and see the power of digital imaging at your fingertips.

Before You Transfer Your Pictures

Before you transfer your pictures from the camera to the computer, make sure you have installed the software from the KODAK Picture Software CD (page 45).

MACINTOSH OS X users, see note on page 46 before installing software.

Connecting to Your Computer

You can transfer your pictures from your camera to your computer using either the provided USB cable or the KODAK EASYSHARE Camera Dock.

Connecting With the USB Cable

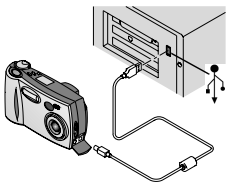

- 1 Plug the labeled () end of the USB cable into the labeled USB port on your computer. If the port is not labeled, see your computer User's Guide.
- 2 Plug the other end of the USB cable into the labeled USB port on the camera.

Connecting With the KODAK EASYSHARE Camera Dock

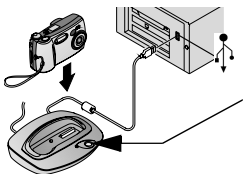

- 1 Open the connection door on the bottom of the camera.
- 2 Place the camera in the Camera Dock.
- 3 Push the Connect button.

For more information, see [Chapter 8, Using the KODAK EASYSHARE Camera Dock](#).

NOTE: You can also use a KODAK USB Picture Card Reader to transfer your pictures. See your KODAK retail dealer or visit our Web site at <http://www.kodak.com/go/accessories>.

Transferring Your Pictures

KODAK Picture Transfer Software automatically opens on your computer when you have connected as shown in the previous section, [Connecting to Your Computer](#).

Welcome to KODAK Picture Transfer Software

Transferring on a WINDOWS-based Computer

- To transfer your pictures to the computer using current settings, click Transfer Now .

Your pictures are transferred to the following default location on your computer: C:\Kodak Pictures.

- To change the default transfer options, click Setup  before you click Transfer Now.

Transferring on a MACINTOSH Computer

- Select the Automatic Transfer radio button, then click Transfer.

Automatic Transfer copies all the pictures from the picture storage location to your computer using the current settings.

- Or, select the Guided Transfer radio button, then click Transfer.

Guided Transfer lets you review each picture, give it a name, and select a destination folder on your computer.

Turning Off KODAK Picture Software Auto-start

If you do not want Picture Transfer Software and Picture Software to start automatically, you can bypass the auto-start feature. For this and other detailed information on using Picture Transfer Software, refer to the online help:

On a WINDOWS-based computer—right-click the Picture Transfer icon on the taskbar, then select *Learn more about this application*.

On a MACINTOSH computer—click the Help icon (?) in the application window.

Working With Your Pictures

When your pictures are transferred, Picture Transfer Software closes and KODAK Picture Software opens.

With KODAK Picture Software you can:

- Add special effects to your pictures, fix red-eye, crop, and rotate.
- Print to your personal printer.
- E-mail pictures to family and friends.

Refer to the KODAK Picture Software online help for details on using the software.

Transferring Your Pictures Manually

KODAK Camera Connection Software lets you directly access the pictures in your camera and allows you to: display and browse thumbnails of your pictures, copy all or selected pictures to your computer, open a picture directly in third-party applications, delete pictures from a storage location, format the Picture Card, and view information on a selected picture.

Connect your camera to the computer ([page 49](#)) and access your pictures as follows:

On a WINDOWS-based Computer

- When you connect your camera to the computer ([page 49](#)), the camera appears in the My Computer window as a removable drive icon.
- Double-click the camera icon in the My Computer window.
- The Camera window opens and displays the DCIM folder. To see the picture files, double-click the DCIM folder, then the 100K3900 folder.

On a MACINTOSH Computer

- The Picture Card is displayed as an icon on the desktop.
- If the icon is not displayed, turn off the camera and then turn it back on.

See [page 83](#) for information on picture names and locations.

KODAK Camera Connection Software Online Help

For detailed information on using Camera Connection Software, refer to the online help:

On a WINDOWS computer—right-click the camera icon in the My Computer window, then select Camera Help.

On a MACINTOSH system—on the Finder menu bar, choose Camera → Camera Help.

Printing Your Pictures

Choose your favorite method to enjoy long-lasting prints of your digital pictures.

From KODAK Picture Software

- Print to your home printer with KODAK Premium Picture Paper.

From a Picture Card

- Use the Print Order feature ([page 37](#)) to automatically print from a Picture Card directly to a KODAK Personal Picture Maker or other direct-print-enabled printer.
- Take your Picture Card to your local photo retailer for printing.
- Make your own prints at any KODAK Picture Maker.

8 Using the KODAK EASYSHARE Camera Dock

The KODAK EASYSHARE Camera Dock (Camera Dock) makes it easier than ever to transfer your pictures to the computer. In addition, the Camera Dock is a rapid battery charger for the included KODAK Ni-MH Rechargeable Battery Pack, and the Camera Dock supplies power to the camera.

To keep the Battery Pack charged and the camera always ready to take pictures, store your camera in the Camera Dock whenever you are not using it.

NOTE: A Dock insert, packaged with all KODAK DX-series cameras, is required to custom-fit your camera into the Camera Dock.

If a KODAK EASYSHARE Camera Dock was not included with your camera, you can purchase one as an accessory. See your KODAK retail dealer or visit our Web site at <http://www.kodak.com/go/accessories>.

Camera Dock Package Contents

The Camera Dock is packaged with the following items.

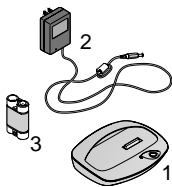

- 1 KODAK EASYSHARE Camera Dock
- 2 AC power adapter
Some AC adapters may be different from the one pictured.
- 3 KODAK Ni-MH Rechargeable Battery Pack
- 4 Quick Start Guide (not shown)

Installing the Dock Insert

KODAK DX-series cameras are packaged with a Dock insert, which is used to custom-fit the camera to the Camera Dock.

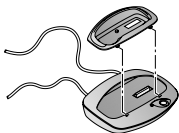

- 1 Place the front tabs on the insert into the slots in the Camera Dock cavity.
- 2 Fit the insert down into the cavity and snap the insert into place.

To order an insert for your camera, contact Kodak Customer Support, see [page 72](#).

Connecting the Camera Dock

Connect the Camera Dock to your computer and to an external power source. You will need the USB cable that is included with your camera and the AC adapter that is included with the Camera Dock.

Make sure your camera is not in the Camera Dock when you are connecting to external power and the computer.

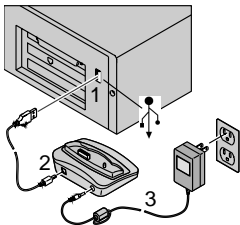

- 1 Plug the labeled (↑↓) end of the USB cable into the labeled USB port on your computer. For details, see your computer User's Guide.
- 2 Plug the other end of the USB cable into the labeled USB connector on the back of the Camera Dock.
- 3 Plug the AC adapter into the back of the Camera Dock and into a power outlet.

Your AC adapter may be different from the one pictured, or may have additional plugs. Use the plug that accommodates your type of power outlet. Leave the Camera Dock connected to the computer for easy access when transferring pictures, charging the Battery Pack, and providing power to the camera.

Installing the Battery Pack in the Camera

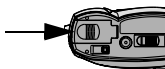

- 1 Open the battery door on the bottom of the camera.
- 2 Install the Battery Pack in the direction of the arrows, as illustrated.

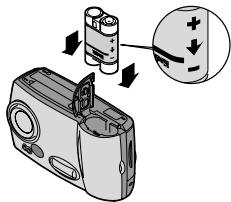

CAUTION:

The Battery Pack can only be inserted into the camera in the orientation shown. If the Battery Pack does not easily install, reposition it and try again. **DO NOT FORCE IT.** Doing so can damage your camera.

- 3 Close the battery door.

IMPORTANT: The batteries in the Battery Pack are not charged when you receive it. See [page 58](#) for charging instructions.

Docking the Camera

When you are ready to transfer your pictures from the camera to the computer, or charge the Battery Pack, place the camera in the Camera Dock.

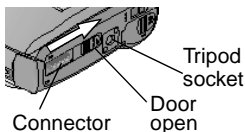

- 1 Turn **off** the camera.
- 2 On the camera bottom, slide the dock connection door until it clicks open.

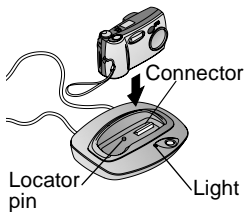

- 3 Place the camera in the Camera Dock and push down to seat the connectors; the Dock locator pin fits into the camera tripod socket.

The Camera Dock light glows green when the connectors are properly seated. The camera is now powered by the Camera Dock instead of the camera batteries.

NOTE: If the Battery Pack in the camera requires charging, the Camera Dock light turns red after a few seconds and charging begins.

Charging the Battery Pack

The batteries in the Battery Pack are not charged when you receive it.

- 1 Turn **off** the camera.
- 2 Make sure the Battery Pack is installed in the camera.
- 3 Place the camera in the Camera Dock (see [page 57](#)).
 - Charging begins after a few seconds.
 - The Camera Dock light glows red while charging, then glows green when the Battery Pack is fully charged.
 - Full charging takes about 2.5 hours. After the Battery Pack is fully charged, leave the camera in the Camera Dock. It continually senses battery power and resumes charging whenever necessary. Under these conditions, there is no red light while charging.
 - Charging stops if you turn on the camera. If the camera is left in the Camera Dock with the power on, charging resumes when the camera enters automatic power down mode (see [page 6](#)).

NOTE: The Camera Dock only charges the KODAK Ni-MH Rechargeable Battery Pack. If you place the camera in the Camera Dock with any other type of batteries, rechargeable or not, no charging takes place.

Transferring Pictures

To transfer pictures from your camera to your computer:

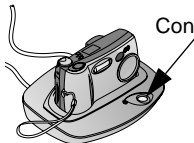

- 1 Place the camera in the Camera Dock.
- 2 Push the Connect button.
 - The Camera Dock light blinks green while the connection to the computer is active.

- If installed, KODAK Picture Transfer Software automatically opens on your computer and your pictures are transferred.

You can also transfer your pictures manually while the green light is blinking. See [page 52](#).

- Then, KODAK Picture Software opens so you can work with your pictures on your computer. For further details, see [Chapter 7, Using Pictures on Your Computer](#).

NOTE: When your pictures are transferred, leave the camera in the Camera Dock. Ten minutes after the transfer is complete, the Camera Dock begins to monitor battery power and then begins charging whenever necessary.

When Using a Tripod

For stability when using a tripod, remove the camera from the Camera Dock and connect the tripod directly to the camera, rather than through the Camera Dock.

The camera tripod socket is located on the bottom of the camera.

9 Troubleshooting Problems

There may be times when you have questions about using your KODAK EASYSHARE DX3900 Zoom Digital Camera or KODAK EASYSHARE Camera Dock. This chapter helps you find the answers quickly.

Additional technical information is available in the ReadMe file located on the KODAK Picture Software CD. For updates to Troubleshooting information, visit our Web site at <http://www.kodak.com>.

Troubleshooting—Camera

Picture Card (also called a memory card)		
Problem	Cause	Solution
The camera does not recognize your Picture Card.	The Picture Card may not be CompactFlash certified.	Purchase a certified CompactFlash Picture Card (page 4).
	The Picture Card may be corrupt.	Reformat the Picture Card (page 43). Caution: Formatting erases all pictures from the card.
	No Picture Card is inserted in camera.	Insert a Picture Card.
Camera freezes up when a Picture Card is inserted or removed.	Camera detects an error when the Picture Card was inserted or removed.	Turn the camera off, then back on. Make sure the camera is off when inserting or removing a Picture Card.

Camera Communications		
Problem	Cause	Solution
The computer cannot communicate with the camera.	There is a problem with the configuration of the USB port on your computer.	Go to the online help for KODAK Camera Connection Software (page 52), see Getting Started: Connect the Camera to Your Computer. Or, go to www.kodak.com and click Service and Support.
	Camera power is off.	Turn on the camera (page 5).
	Some Advanced Power Management utilities on laptops can turn off ports to save battery life.	See the Power Management section of your laptop user's guide to disable this feature.
	USB cable is not securely connected.	Connect cable to camera and computer ports (page 49).
	Software is not installed.	Install the software (page 45).
	There are too many applications running on your computer.	Disconnect your camera from the computer. Close all software applications, reconnect your camera and try again.

Camera		
Problem	Cause	Solution
Shutter button does not work.	Camera is not turned on.	Turn on the camera (page 5).
	The camera is processing a picture, the viewfinder light is blinking.	Wait until the light stops blinking before attempting to take another picture.
	The Picture Card is full.	Transfer pictures to your computer (page 50), delete pictures from the Picture Card (page 34), or insert a card with available memory.
Part of the picture is missing.	Something was blocking the lens when the picture was taken.	Keep hands, fingers, or other objects away from the lens when taking pictures.
	Your eye or the picture was not centered correctly in the viewfinder.	Leave space around subject when centering picture in viewfinder.
Picture is too dark.	Flash is not on or did not function.	Turn on the flash (page 19).
	The subject is too far away for the flash to have an effect.	Move closer to your subject: no farther than 7.5 ft (2.3 m) in Telephoto, no farther than 10.5 ft (3.2 m) in Wide Angle.
	The subject is in front of a bright light (backlit).	Change your position so the light is not behind the subject.

Camera		
Problem	Cause	Solution
Camera does not turn on.	Battery is not properly installed.	Remove and reinstall the batteries (page 3).
	Battery is not charged.	Replace or recharge the batteries (page 3).
Camera freezes up when a Picture Card is inserted or removed.	Camera detects an error when the Picture Card was inserted or removed.	Turn the camera off, then back on. Make sure the camera is turned off before inserting or removing a Picture Card.
Picture is too light.	The flash is not needed.	Change to Auto flash or turn flash off (page 19).
	The subject is too close when the flash was used.	Move so there is at least 1.6 ft (0.5 m) between the camera and the subject.
	The light sensor is covered.	Hold the camera so your hands or other objects do not cover the light sensor.
Stored pictures are damaged.	The Picture Card was removed when the viewfinder light was blinking.	Make sure the Picture Card access light is not blinking before removing the card.
Pictures remaining number does not decrease after taking a picture.	Picture does not take up sufficient space to decrease the picture remaining number.	The camera is operating normally. Continue taking pictures.

Camera		
Problem	Cause	Solution
Picture is not clear.	The lens is dirty.	Clean the lens (page 80).
	Subject too close when taking picture.	Move so there is at least 1.6 ft (0.5 m) between the camera and the subject. Or use the Close-Up setting (page 17).
	Subject or the camera moved while the picture was taken.	Hold the camera steady while taking the picture.
	The subject is too far away for the flash to be effective.	Move so there is no more than 7.5 ft (2.3 m) between the camera and the subject.
Slide show does not run on external video device.	Video Out setting is incorrect.	Adjust the camera Video Out setting (NTSC or PAL, page 42).
	External device is set incorrectly.	Refer to the external device user's guide.

Camera Status and Messages

Camera Viewfinder Light		
Light Status	Cause	Solution
Viewfinder light blinks red.	Error state.	See LCD screen message.
Viewfinder light glows steady red.	Picture Card is full.	Transfer pictures to your computer (page 50), delete pictures from the Picture Card (page 34), or insert a card with available memory.
	No Picture Card in camera.	Insert a card with available memory.
Viewfinder light blinks yellow.	Insufficient buffer memory.	Wait. Resume picture taking when the light goes off.
Viewfinder light blinks green.	Auto-exposure or auto-focus is not locked.	Release the Shutter button and recompose the picture.

Camera Picture Card Access Light		
Light Status	Cause	Solution
Picture Card access light blinks green.	Picture is being processed and saved to the Picture Card.	Wait. Resume picture taking when the light stops blinking. Do not remove the Picture Card or turn off the camera while the light is blinking.

LCD Messages		
Message	Cause	Solution
Memory card requires formatting	The Picture Card is corrupted, or formatted for another digital camera.	Insert a new Picture Card or format the card (page 43).
Card cannot be read (Format card or insert another card)		
Camera cannot read picture file	The camera cannot read the picture format.	Transfer the unreadable picture to the computer (page 50), or delete the picture (page 34).
Unrecognized file format		
Camera needs service #xxx	A camera error has occurred.	Turn the camera off, then back on. If the error message is still displayed, call for service (page 72).
Memory Card is full	There is no more space on the Picture Card.	Delete pictures (page 34) or insert a new Picture Card.
Date/Time entry screen appears automatically	This is the first time you turned on the camera; batteries have been removed for an extended time; or the batteries are exhausted.	Reset the clock (page 7).

Troubleshooting—EASYSHARE Camera Dock

Camera Dock		
Problem	Cause	Solution
Pictures are not transferred to the computer	AC adapter or USB cable is not securely connected.	Check the connections (page 49).
	Software is not installed.	Install the software (page 45).
	There are too many applications running on your computer.	Close all software applications and try again.
	Camera was removed from the Camera Dock during picture transfer.	Replace the camera on the Camera Dock and press the Connect button.
	Connect button was not pressed	Press the Connect button.

EASYSHARE Camera Dock Status

Camera Dock indicator light		
Light Status	Cause	Solution
Light glows steady green	Camera is docked.	The camera and Camera Dock are operating normally.
Light glows steady red	Camera Dock is charging Battery Pack.	
Light blinks green	Connection (USB) between the computer and the Camera Dock is active.	
Light blinks red	Battery Pack is installed incorrectly.	Reinstall the Battery Pack (page 57).
	The Battery Pack or connector pins are damaged.	Check for damage.
	The camera and Battery Pack have been exposed to very high or low temperatures.	Slowly return the camera and Battery Pack to room temperature.

10 Getting Help

If you need help with your KODAK EASYSHARE DX3900 Zoom Digital Camera or KODAK EASYSHARE Camera Dock, it is available from a number of resources:

- [Troubleshooting Problems, page 61](#)
- Software application online help
- Product information by fax
- Place of purchase
- World Wide Web
- Technical support

Software Help

Help with any software application packaged with your camera can be obtained from the online help provided with the application.

World Wide Web

<http://www.kodak.com> (click Service and Support)

Kodak Fax Support

- U.S. and Canada 1-800-508-1531
- Europe 44-0-131-458-6962

Telephone Customer Support

If you have questions concerning the operation of KODAK software or the camera, you may speak directly to a customer support representative.

Before You Call

Before you call to speak to a customer support representative, please have the camera connected to your computer, be at your computer, and have the following information available:

Operating system _____

Processor speed (MHz) _____

Computer model _____

Amount of memory (MB) _____

Exact error message you received _____

Version of installation CD _____

Camera serial number _____

Telephone Numbers

- **U.S.**—call toll free, 1-800-235-6325, between the hours of 9:00 a.m. and 8:00 p.m. (Eastern Standard Time) Monday through Friday.
- **Canada**—call toll free, 1-800-465-6325, between the hours of 9:00 a.m. and 8:00 p.m. (Eastern Standard Time) Monday through Friday.
- **Europe**—call the Kodak Digital Imaging Support Centre toll free number associated with your location, or the U.K. toll line, 44-0-131-458-6714, between the hours of 09.00 and 17.00 (GMT/CET) Monday through Friday.

○ **Outside the U.S. and Canada**—calls are charged at National Rate.

Australia	1800 147 701
Austria/Osterreich	0179 567 357
Belgium/Belgique	02 713 14 45
China	86 21 63500888 1577
Denmark/Danmark	3 848 71 30
Ireland/Eire	01 407 3054
Finland/Suomi	0800 1 17056
France	01 55 1740 77
Germany/Deutschland	069 5007 0035
Greece	0080044125605
Italy/Italia	02 696 33452
Japan	81 3 5644 5500
Korea	82 2 708 5600
Netherlands/Nederland	020 346 9372
New Zealand	0800 440 786
Norway/Norge	23 16 21 33
Portugal	021 415 4125
Spain/Espana	91 749 76 53
Sweden/Sverige	08 587 704 21
Switzerland/Schweiz/Suisse	01 838 53 51
UK	0870 2430270
International Toll Line	+44 131 4586714
International Toll Fax Number	+44 131 4586962

11 Appendix

This appendix serves as a resource for technical information about your KODAK EASYSHARE DX3900 Zoom Digital Camera, KODAK EASYSHARE Camera Dock, Picture Cards, batteries, and available accessories.

Camera Specifications

Camera Specifications		
Pixel Resolution (by Quality setting)	3.1 MP	2160 x 1440
	2.2 MP	1800 x 1200
	1.6 MP	1536 x 1024
	0.8 MP	1080 x 720
Color		24-bit, millions of colors
Picture File Format		EXIF 2.1 (JPEG compression), DCF
Picture Storage		ATA compatible CompactFlash card
Viewfinder		Optical real image
ASA/ISO Sensitivity		Automatic (100 - 400) Selectable (100, 200, 400)
Flash Range	Wide	1.6 to 10.5 ft (0.5 to 3.2 m)
	Telephoto	1.6 to 7.5 ft (0.5 to 2.3 m)
Tripod Socket		.25 in. (.006 m) threaded
Video Out		NTSC or PAL
Operating Temperature		32 to 104 ^o F (0 to 40 ^o C)

Camera Specifications		
Power	Batteries	2 Lithium, AA KODAK Lithium Battery, KCRV3 2 Ni-MH, AA rechargeable Alkaline batteries not recommended
	Battery Pack, Camera Dock only	KODAK Ni-MH Rechargeable Battery Pack, recharge in Camera Dock only. Dock provides power to the camera.
Lens	Type	Optical quality glass
	Maximum Aperture	Wide: f/2.8 Telephoto: f/4.0
	Zoom	6X: 2X Optical zoom 3X Digital zoom
	Focal Length	35 to 70 mm (equivalent to 35 mm camera) 7.3 to 14.6 mm (.29 to .57 inches) actual
	Focus Distance	Standard: 1.6 ft (0.5 m) to infinity
	Focus Distance, Close-Up	Wide: 0.2 to 2.3 ft (0.07 to 0.7 m) Telephoto: 0.8 to 2.3 ft (0.25 to 0.7 m)
Dimensions	Width	4.6 in (116 mm)
	Length	1.7 in (42 mm)
	Height	2.6 in (67 mm)
Weight	7.9 oz. (225 g) without batteries	

Camera Dock Specifications

Camera Dock Specifications		
Communication with computer	USB	Cable included with KODAK DX-series cameras
Dimensions (without insert)	Width/Depth/Height	5.9 in. /4.4 in. /1.5 in. (150 mm/112.5 mm/38.5 mm)
	Weight	5.5 oz. (155 g)
Dimensions (with insert)	Width/Depth/Height	5.9 in. /4.4 in. /1.7 in. (150 mm/112.5 mm/42.5 mm)
	Weight	6.2 oz. (175 g)
Indicator light		2-color LED indicates operating/charging
Input voltage		7 ±0.7 V DC
Power	DC input	AC adapter included with Camera Dock

Original Factory Settings—Camera

Your camera is set to the following defaults at the factory:

Feature	Factory Setting
Camera Sounds	Selected on
Color Mode	Color
Date/Time	2000/01/01; 12:00
Digital Zoom	Pause
Exposure Compensation	0.0
Exposure Metering	Multi-pattern

Feature	Factory Setting
Flash	Auto
ISO Speed	Auto
Quality	3.1 MP (highest resolution)
Sharpness	Standard
Shutter Speed	Auto
Slide Show Interval	10 seconds
Video Out	NTSC
White Balance	Auto

Power Save—Camera Performance

You can choose from three Power Save settings (On, Standard, Off) to balance battery consumption with camera performance (see [page 39](#)). The table below describes the effect of the Power Save settings on camera functions.

Camera Function	POWER SAVE ON	STANDARD	POWER SAVE OFF
Preview Frame Rate	15 fps	30 fps	30 fps
LCD Brightness	Low	Normal	Normal
Slide Show Loops	1 loop	5 loops	Unlimited
Simultaneous LCD/Television display	No	No	Yes
Automatic QuickView	Yes	Yes	Yes

Using Your Batteries

- **Replacement Types**—your camera can use the following battery types:
 - 2, 1.5 volt AA lithium batteries
 - 1, KODAK Lithium Battery, KCRV3 *
 - 1, KODAK Ni-MH Rechargeable Battery Pack, rechargeable in the KODAK EASYSHARE Camera Dock *
 - 2, 1.2 volt AA Nickel Metal Hydride (Ni-MH) batteries, rechargeable *
- * These batteries can be purchased by visiting our Web site at <http://www.kodak.com/go/accessories>.
- For acceptable battery life, and to make sure your camera operates dependably, **we do not recommend or support alkaline batteries.**
- **To lengthen battery life**, limit the following activities:
 - Using Preview (using the LCD screen as the viewfinder, see [page 15](#))
 - Reviewing your pictures on the LCD screen (see [page 31](#))
 - Excessive use of the flash
- **NOT ALL BATTERIES ARE CREATED EQUAL!** Battery life depends significantly on battery age, usage conditions, type, and brand. Digital camera requirements are very demanding on batteries. Not all batteries perform well under these challenging conditions. For a comparison of different battery types, refer to the Battery Option sheet that is included with your camera.
- Battery performance is reduced at temperatures below 41 °F (5 °C). Carry spare batteries when using your camera in cold weather, and keep them warm until you are ready to take pictures. Do not discard cold batteries that do not work. Once they are warmed, they may be usable.

Tips, Safety, Maintenance

- Always follow basic safety precautions. Refer to the “Important Safety Instructions” booklet packed with your camera.
- Do not allow any chemicals, such as suntan lotion, to come into contact with the painted surface of the camera.
- If the camera has been subjected to inclement weather or you suspect water has gotten inside the camera, turn off the camera and remove the battery and Picture Card. Allow all components to air-dry for at least 24 hours before using the camera again.
- Clean the lens and back LCD screen:
 - 1 Blow gently on the lens or LCD screen to remove dust and dirt.
 - 2 Moisten the lens or LCD screen by breathing lightly on it.
 - 3 Wipe the lens or LCD screen gently with a soft, lint-free cloth or an untreated lens-cleaning tissue.

Do not use cleaning solutions unless they are designed specifically for camera lenses. **Do not wipe the camera lens or LCD screen with chemically treated eyeglass lens tissue. It may scratch the lens.**

- Clean the outside of the camera by wiping with a clean, dry cloth. Never use harsh or abrasive cleaners or organic solvents on the camera or any of its parts.
- Service agreements are available in some countries. Please contact a dealer of Kodak products for more information.

Camera Accessories



Get the most from your KODAK EASYSHARE DX3900 Zoom Digital Camera by adding just the right accessories. Expand your capture options. Increase your picture storage. Or extend your battery life.

For a full range of KODAK accessories, see your Kodak retailer or visit our Web site at <http://www.kodak.com/go/accessories>.

KODAK Accessories

EASYSHARE Camera Dock	Enables quick picture transfer, charges the included Battery Pack, and provides power to the camera
Ni-MH Rechargeable Battery Pack	Rechargeable with the KODAK EASYSHARE Camera Dock only, the Battery Pack ensures you'll always have fully powered batteries
Lithium Battery, KCRV3	Lightweight battery pack fits perfectly in your camera and offers superior battery life
Picture Cards	CompactFlash Type I—removable memory, many sizes available, including: 8, 16, 32, 64, 96, 128, and 192 MB
Lens adapter and lenses	Custom adapter allows you to use additional lenses for flexibility and versatility in your picture taking
Premium Picture Paper	Print photo-quality pictures on your home printer

Picture Storage Capacities

Picture Cards are available in many different sizes, or storage capacities. The table below indicates approximately how many pictures, using typical file sizes, can be stored on different size Picture Cards.

Picture file sizes can vary. You may be able to store more or fewer pictures.

Quality Setting	Store this many pictures at:				
	3.1 MP	3.1 MP (high compr)	2.2 MP	1.6 MP	0.8 MP
8 MB Picture Card	7	15	10	13	23
16 MB Picture Card	16	32	21	28	48
64 MB Picture Card	64	133	87	117	196
96 MB Picture Card	97	194	127	170	286
192 MB Picture Card	194	390	255	341	574

KODAK Picture Cards can be purchased separately on our Web site at <http://www.kodak.com/go/accessories>.

Use only certified cards that carry the CompactFlash logo.



Locating Pictures on a Picture Card

Pictures stored on a KODAK Picture Card use a standard agreed upon by many camera manufacturers. This allows you to use the Picture Card in different cameras. If you use a card reader to retrieve your files or you cannot locate them using the software, the following description of the Picture Card file structure may be helpful.

MISC folder—contains the Print Order file created when you use the Print Order feature.

SYSTEM folder—used for updating camera firmware.

DCIM folder—root level folder, contains the 100K3900 folder. Each time you turn on the camera or insert a different Picture Card, any empty folders within the DCIM folder are removed.

100K3900 subfolder—contains all the pictures on the Picture Card.

Picture Card File Naming Conventions

- Pictures are named DCP_####.JPG, and are numbered in the order in which they are taken. The first picture is named DCP_0001.JPG; the highest number allowed is DCP_9999.JPG.
- When a Picture Card contains a picture named DCP_9999.JPG in the \DCIM\100K3900 folder, subsequent pictures appear in a new folder (\DCIM\101K3900), beginning with picture DCP_0001.JPG.
- Even if you transfer pictures to the computer or delete pictures from the camera, the camera continues to use consecutive numbers for all subsequent pictures. For example, if the last picture taken was DCP_0007.JPG and you delete it, the next picture you take is named DCP_0008.JPG.
- When you insert a different Picture Card into your camera, the next picture number is defined by incrementing the higher of the last picture taken by the camera, or the highest existing picture number in the folder.
- If you use the Picture Card in a camera other than the DX3900, and that camera manufacturer adheres to this file structure standard, the \DCIM folder contains a folder named by that camera. For more information, refer to the documentation that accompanied that camera.

Upgrading Your Software and Firmware

Take advantage of the latest enhancements to your KODAK software and camera firmware. Software refers to the applications included on the KODAK Picture Software CD. Camera firmware is the internal software that runs on the camera.

To download the latest versions of software and firmware, go to:

<http://www.kodak.com/go/dx3900/Download>.

Regulatory Information

FCC Compliance and Advisory

This device complies with Part 15 of the FCC Rules. Operation is subject to the following two conditions: 1) this device may not cause harmful interference, and 2) this device must accept any interference received, including interference that may cause undesired operation.

This equipment has been tested and found to comply with the limits for a Class B digital device, pursuant to Part 15 of the FCC Rules. These limits are designed to provide reasonable protection against harmful interference in a residential installation.

This equipment generates, uses, and can radiate radio frequency energy and, if not installed or used in accordance with the instructions, may cause harmful interference to radio communications. However, there is no guarantee that interference will not occur in a particular installation.

If this equipment does cause harmful interference to radio or television reception, which can be determined by turning the equipment off and on, the user is encouraged to try to correct the interference by one or more of the following measures: 1) reorient or relocate the receiving antenna; 2) increase the separation between the equipment and the receiver; 3) connect the equipment to an outlet on a circuit different from that to which the receiver is connected; 4) consult the dealer or an experienced radio/TV technician for additional suggestions.

Any changes or modifications not expressly approved by the party responsible for compliance could void the user's authority to operate the equipment. Where shielded interface cables have been provided with the product or specified additional components or accessories elsewhere defined to be used with the installation of the product, they must be used in order to ensure compliance with FCC regulation.

Canadian DOC Statement

DOC Class B Compliance—This digital apparatus does not exceed the Class B limits for radio noise emissions from digital apparatus set out in the radio interference regulations of the Canadian Department of Communications.

Observation des normes-Class B—Le présent appareil numérique n'émet pas de bruits radioélectriques dépassant les limites applicables aux appareils numériques de la Classe B prescrites dans les règlements sur le brouillage radioélectrique édictés par le Ministère des Communications du Canada.

VCCI Class B ITE

この装置は、情報処理装置等電波障害自主規制協議会（VCCI）の基準に基づくクラスB情報技術装置です。この装置は、家庭環境で使用することを目的としていますが、この装置がラジオやテレビジョン受信機に近接して使用されると、受信障害を引き起こすことがあります。
取扱説明書に従って正しい取り扱いをして下さい。

English translation:

This is a Class B product based on the standard of the Voluntary Control Council for Interference from Information Technology Equipment (VCCI). If this is used near a radio or television receiver in a domestic environment, it may cause radio interference. Install and use the equipment according to the instruction manual.

Index

A

- access light, Picture Card 66
- accessories 81
- adjusting
 - camera sounds 41
 - color mode 23
 - exposure compensation 21
 - exposure metering 25
 - ISO speed 27
 - picture quality 24
 - resolution, compression 24
 - sharpness 26
 - white balance 22
- attaching, wrist strap 2
- auto shutoff 6
- automatic
 - flash 19
 - powerdown 6
 - printing, print orders 37

B

- backlit scenes 21
- batteries
 - charging Battery Pack 58
 - checking power level 6
 - extending battery life 79

guidelines 79

loading 3

loading Battery Pack 57

low or exhausted 6

replacement types 79

safety 80

tips 79

using power save 39

with Camera Dock 55

Battery Pack, Camera Dock

charging 58

installing 57

beeps, adjusting 41

black & white pictures, taking

23

burst 16

button

distant/close-up 17

flash 19

self-timer 20

C

cables

AC power 55

connecting Camera Dock 56

provided with camera 2

- provided with Camera Dock
 - 55
- USB 2
- video 2
- camera
 - accessories 81
 - cleaning 80
 - connecting problems 62
 - information, viewing 44
 - maintenance 80
 - original defaults, resetting 44
 - original factory defaults 77
 - package contents 2
 - problems 63
 - safety 80
 - specifications 75
 - turning on and off 5
- Camera Connection Software
 - about 47
 - online help 52
 - transferring pictures 52
- Camera Dock
 - charging Battery Pack 58
 - installing insert 56
 - loading camera 57
 - package contents 55
 - power connection 56
 - specifications 77
 - transferring pictures 59
 - USB connection 56
 - using 55
- Canadian compliance 85
- capture, mode dial 8
- caring for your camera 80
- center spot metering 25
- center-weighted metering 25
- charging Battery Pack 58
- cleaning camera, lens 80
- clock, setting 7
- close-up scenes 17
- color pictures, taking 23
- communication problems 62
- CompactFlash 4
- computer
 - connecting camera 49
 - running a slide show 36
 - system requirements 48
 - transferring pictures to 49, 50, 52
 - using pictures on 49
- connect camera
 - with Camera Dock 50
 - with USB cable 49
- connect Camera Dock 56
- continuous digital zoom 40
- copy pictures
 - to computer 49, 50, 52,

- 59
- cover, lens 5
- customer support numbers 72
- customizing settings
 - camera setup 39
 - for picture taking 21
 - review 31
- D**
- date
 - placing on pictures 29
 - setting 7
- DCIM folder, Picture Card 82
- defaults
 - original settings 77
 - resetting 44
- deleting
 - from Picture Card 34
 - last picture 14
 - protecting pictures from 35
- digital pictures, using 1, 49
- digital zoom 18
 - setting 40
- display problems 63
- displaying
 - pictures on LCD screen 31
 - slide show 36
- distant scenes 17
- dock insert 2, 56
- docking camera 57
- downloading pictures 49, 50, 52, 59
- E**
- editing pictures 51
- error messages 67
- exposure
 - adjusting compensation 21
 - long time 28
 - metering 25
- F**
- fax numbers, support 71
- FCC compliance 84
- file names, Picture Card 83
- filmstrip, displaying 32
- firmware, upgrading 83
- flash
 - auto 19
 - fill 19
 - red-eye 19
 - using 19
- flourescent, adjusting for 22
- folders, Picture Card 82
- formatting, Picture Card 43
- G**
- guidelines, battery 79

H

help

- online service 71
- online, Picture Transfer 51
- online, software 52
- telephone support 72
- troubleshooting camera 61
- troubleshooting Camera Dock 68

I

index print, printing 37

information

- camera, viewing 44
- picture, viewing 38

insert, dock 2, 56

installing

- batteries 3
- Battery Pack 57
- Picture Card 4
- software 45

ISO speed, adjusting 27

K

KODAK software

- Camera Connection 47
- getting help 71
- installing 45
- Picture 47

Picture Transfer 47

L

language, selecting 42

LCD

- error messages 67
- previewing pictures 15
- viewing pictures on 31

lens

- cleaning 80
- cover 5
- specifications 76

light

- Camera Dock 69
- viewfinder, camera 66

lighting, adjusting for 22

loading

- batteries 3
- Battery Pack 57
- Picture Card 4
- software 45

M

MACINTOSH

- installing software on 45
- OS X 46
- system requirements 48

magnify picture 33

maintenance, camera 80

- manual settings 21
- memory card
 - inserting and removing 4
 - storage capacities 82
- menus
 - camera setup 10
 - capture 8
 - navigating 11
 - overview 8
 - review 9
 - reviewing pictures 9
 - setup 10
 - taking pictures 8
- metering, setting exposure 25
- MISC folder, Picture Card 82
- mode dial
 - capture 8
 - overview ii
 - review 9
 - settings and menus 8
 - setup 10
- modes
 - capture 8
 - review 9
 - setup 10
- monitor
 - requirements 48
 - running a slide show 36
- multi-pattern metering 25
- N**
 - navigating, menus 11
 - NTSC, setting video out 42
- O**
 - optical zoom 18
 - OS X, MACINTOSH 46
 - overview
 - camera i, ii
 - camera menus 8
 - status display iii
- P**
 - package contents
 - camera 2
 - Camera Dock 55
 - PAL, setting video out 42
 - pause, digital zoom 40
 - personalizing camera 39
 - photo paper, purchasing 81
 - Picture Card
 - access light 66
 - file name conventions 83
 - file structure 82
 - formatting 43
 - inserting 4
 - problems 61
 - purchasing 81
 - removing 4

- storage capacities 82
 - Picture Software
 - about 47
 - editing pictures 51
 - Picture Transfer Software
 - about 47
 - online help 51
 - transferring pictures 50
 - pictures
 - black & white 23
 - color 23
 - customizing settings 21
 - deleting 34
 - editing 51
 - file naming 83
 - information, viewing 38
 - locating on computer 50
 - locating on Picture Card 83
 - magnifying 33
 - printing 53
 - protecting 35
 - quality, adjusting 24
 - reviewing 31
 - selecting for printing 37
 - sepia 23
 - sharpness, setting 26
 - storage capacity 82
 - taking 13
 - transferring manually 52
 - transferring to computer
 - 49, 50, 59
 - using on computer 49, 51
 - viewing 31
 - power
 - Camera Dock 56
 - checking batteries 6
 - turning camera on 5
 - power save, setting 39
 - powerdown, automatic 6
 - preview pictures 15
 - print orders, automatic printing 37
 - printing
 - automatic, print orders 37
 - from a Picture Card 53
 - from Picture Software 53
 - index prints 37
 - protecting pictures 35
- Q**
- quality settings, picture capacity 82
 - quality, setting 24
- R**
- RAM, requirements 48
 - ReadMe file 61
 - red-eye, flash 19

- regulatory information 84, 85
- replacement batteries, types 79
- requirements
 - MACINTOSH system 48
 - WINDOWS-based system 48
- resolution, setting 24
- review, mode dial 9
- reviewing pictures 31
 - deleting 34
 - for printing 37
 - magnifying 33
 - menus 9
 - on LCD 31
 - picture information 38
 - protecting 35
 - slide show 36
- running slide show 36
- S**
- safety 80
- selecting menus and options 11
- self-timer 20
- sepia pictures, taking 23
- series of pictures 16
- service and support
 - fax numbers 71
 - Kodak web site 71
 - telephone numbers 72
- setting
 - clock 7
 - date and time on pictures 29
 - digital zoom 40
 - exposure metering 25
 - flash 19
 - ISO speed 27
 - language 42
 - mode dial menus 8
 - original camera defaults 44
 - picture quality 24
 - picture sharpness 26
 - power save 39
 - resolution, compression 24
 - shutter speed 28
 - video out signal 42
- settings
 - camera setup 39
 - picture taking 21
 - review 31
- setup
 - customizing settings 39
 - mode dial 10
- sharpness, setting 26
- shutoff, auto 6
- shutter
 - problems 63
 - self-timer delay 20
- shutter speed, setting 28

- sleep mode 6
- slide show
 - problems 65
 - running 36
- software
 - getting help 71
 - included with camera 47
 - installing 45
 - installing on MAC OS X 46
 - KODAK Camera Connection 47
 - KODAK Picture 47
 - KODAK Picture Transfer 47
 - upgrading 83
- specifications
 - camera 75
 - Camera Dock 77
 - MACINTOSH system 48
 - WINDOWS-based system 48
- status display
 - battery symbol 6
 - overview iii
- status light
 - Picture Card access 66
- storage capacity, memory 82
- System folder, Picture Card 82
- system requirements
 - MACINTOSH 48
 - WINDOWS 48
- T**
- taking pictures
 - burst 16
 - close-up 17
 - distant 17
 - general 13
 - menus 8
- telephone support 72
- telephoto zoom 18
- television, slide show 36
- time
 - placing on pictures 29
 - setting 7
- timer, shutter delay 20
- tips
 - battery guidelines 79
 - maintenance 80
 - ReadMe file 61
 - safety 80
- transferring pictures to
 - computer 49, 50, 52, 59
- tripod 59
 - use with long time exposure 28
 - use with self-timer 20
- troubleshooting problems
 - camera 63
 - camera communications 62
 - Camera Dock 68

Camera Dock light 69
camera viewfinder light 66
LCD messages 67
Picture Card 61
Picture Card access light 66
tungsten lighting, adjusting for
22
turning camera on and off 5

U

upgrading software, firmware
83
using
batteries 79
Camera Dock 55
pictures on computer 49

V

VCCI compliance 85
video out signal, setting 42
viewfinder light, status 66
viewing
camera information 44
picture information 38
viewing picture
after taking 14, 31
before taking 15
magnified 33
on Picture Card 31

W

web site, Kodak 71
white balance 22
wide angle zoom 18
WINDOWS
installing software 45
system requirements 48
wrist strap, attaching 2

Z

zoom
digital 18
digital, setting 40
optical 18