1 Installing the software



Before connecting any cables, install the software that was included with your camera. Follow the on-screen instructions.



After installing the software, return to this Getting Started Guide.

2 Loading the KLIC-7004 battery

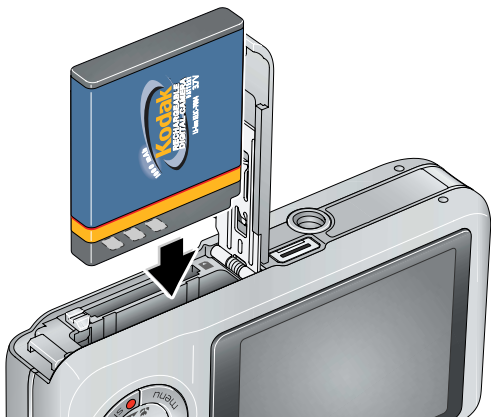

3 Charging the battery

Charge using a USB computer

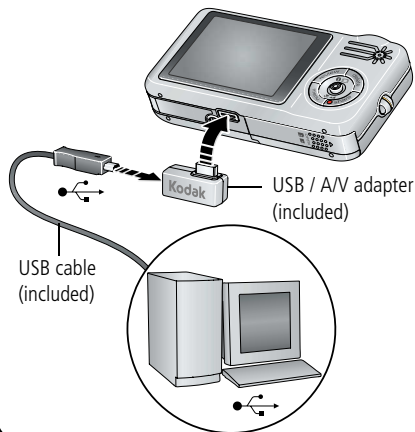

Charge using a Kodak 5V AC adapter (may be sold separately)

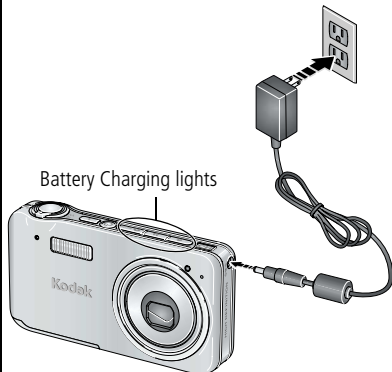

Charge until all 3 Battery Charging lights are lit.

If the Battery Charging lights do not turn on during USB charging, ensure:

- The USB cable is connected to a powered USB port
- The computer is turned on, and not in sleep mode

For more on USB charging, visit www.kodak.com/go/USBcharging.

To purchase accessories, visit www.kodak.com/go/v1233accessories.

4 Turning on the camera

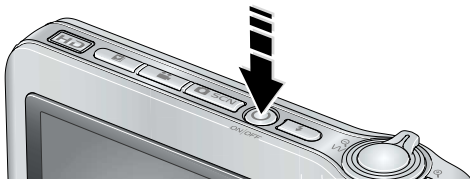

5 Setting the language, date/time

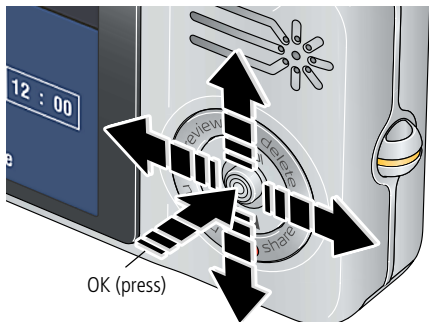

Language:

- ① ▲/▼ to change.
- ② OK to accept.

Date/Time:

- ① At the prompt, press OK.
- ② ▲/▼ to change.
◀/▶ for previous/next field.
OK to accept.

6 Taking a picture/video

Pictures



- ① Press the On/Off or the Auto/SCN mode button to turn on the camera.
- ② Press the Shutter button **halfway** to focus and set exposure.

When the framing marks turn green, press the Shutter button **completely down**.

Videos



- ① Press the Video mode button.
- ② Press the Shutter button **completely down**, then release it.

To stop recording, press and release the Shutter button again.

7 Reviewing pictures/videos



- 1 Press Review.
(Press again to exit.)
- 2 ◀/▶ for previous/next.

Videos:

- ▶ Play. (Press OK to pause/unpause.)
- ▶/◀ During playback to adjust the volume.
- ▶ During playback to play at 2X speed; press again for 4X.
- ◀ During playback to reverse at 2X speed; press again for 4X.
- ◀/▶ Press and hold for 4 seconds to jump to a bookmark.

8 Transferring pictures/videos

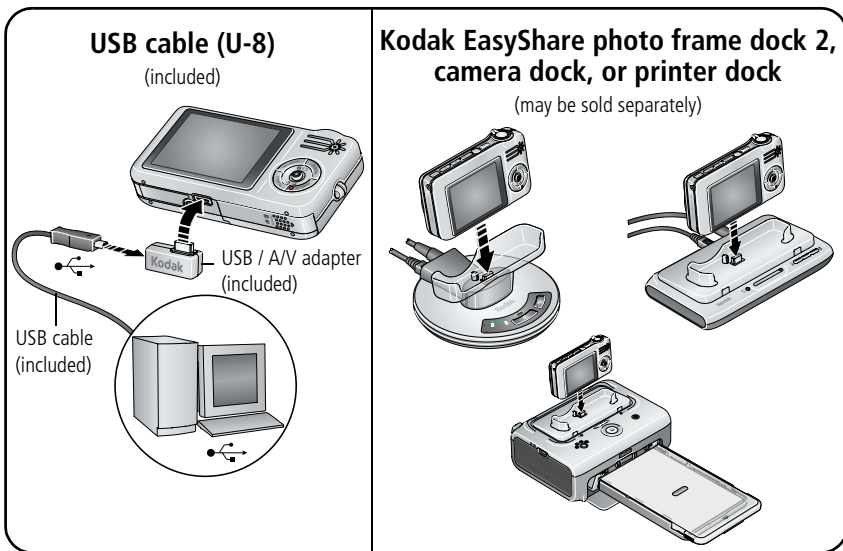

For package contents, see your product package. To use a dock, see its Getting Started Guide. For dock compatibility, visit www.kodak.com/go/dockcompatibility. To purchase accessories, visit www.kodak.com/go/v1233accessories.

9

Keep learning about your camera!

Congratulations! You have:

- set up your camera
- taken pictures
- transferred pictures to your computer

Keep learning!

Finish reading this book, so you can take and share your best pictures!
To better understand each menu option, use camera Help.
(Highlight a menu choice, then press the Zoom telephoto T button.)

Visit www.kodak.com/go/v1233support for:

- the user's guide
- interactive troubleshooting and repairs
- interactive tutorials
- FAQs
- downloads
- accessories
- printing information
- product registration



Front view

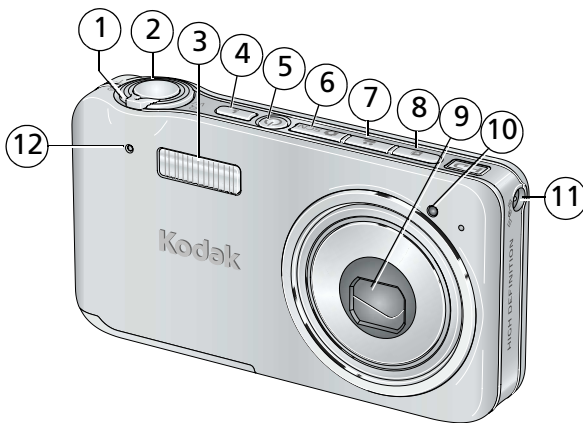

- | | | | |
|---|------------------------------|----|--|
| 1 | Zoom lever (W/T) | 7 | Video mode button |
| 2 | Shutter button | 8 | Favorites mode button |
| 3 | Flash | 9 | Lens |
| 4 | Flash button | 10 | Video light/Self-timer light/AF assist light |
| 5 | On/Off button | 11 | DC-In (5V) |
| 6 | Auto/SCN (scene) mode button | 12 | Microphone |

NOTE: 6, 7, and 8 are also Battery Charging lights.

Back view

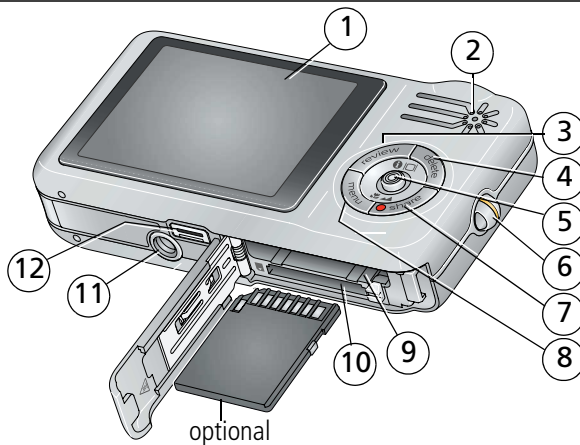

- | | | | |
|---|--|----|----------------------------------|
| 1 | LCD | 7 | Share button |
| 2 | Speaker | 8 | Menu button |
| 3 | Review button | 9 | Battery compartment |
| 4 | Delete button | 10 | Slot for optional SD or MMC card |
| 5 | Joystick   ; OK button (press) | 11 | Tripod socket |
| 6 | Strap post | 12 | USB, A/V Out, Dock connector |

1

Doing more with your camera

Storing pictures on an SD or MMC card

Your camera has internal memory. You can purchase an SD or MMC card to conveniently store more pictures/videos (visit www.kodak.com/go/v1233accessories).



CAUTION:

A card can only be inserted one way; forcing it may cause damage. Inserting or removing a card while it is being accessed may damage the pictures, the card, or the camera.

- 1 Turn off the camera.
- 2 Insert or remove the optional card.
- 3 Turn on the camera.

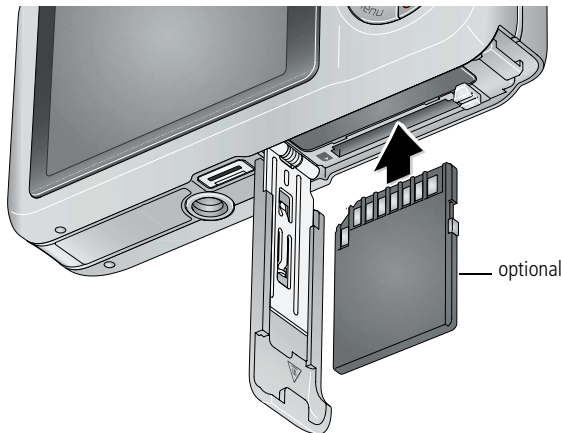

Using the 3X optical zoom

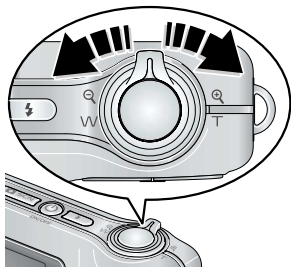

- 1 Use the LCD to frame your subject.
- 2 To zoom in, press Telephoto (T).
To zoom out, press Wide Angle (W).
The zoom indicator shows the zoom status.
- 3 Take the picture or video.

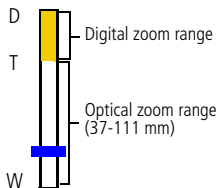

Using digital zoom

Use digital zoom in any picture-taking mode to get up to 5X magnification beyond optical zoom. (You cannot use digital zoom for video recording.)

Press Telephoto (T) until the slider is at the top of the optical zoom range. Release Telephoto (T), then press it again.

NOTE: You may notice decreased image quality when using digital zoom. The slider pauses and turns red when the picture quality reaches the limit for an acceptable 4 x 6-in. (10 x 15 cm) print.

Using the self-timer

Use the self-timer when you want to be included in a picture or to ensure a steady Shutter button press. Place camera on a tripod or flat surface.

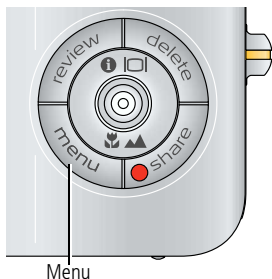

- 1 In any Still mode, press the Menu button.
- 2 Press ▲/▼ to highlight Self-Timer, then press OK.
- 3 Press ▲/▼ to highlight:

10 seconds—A picture is taken after a 10-second delay (so you have time to get into the scene).

2 seconds—A picture is taken after a 2-second delay (for a steady, auto-shutter release on a tripod).

2 shot—The first picture is taken after a 10-second delay. A second picture is taken 8 seconds later.

- 4 Press OK, then the Menu button.
- 5 Compose the scene.
- 6 Press the Shutter button **halfway**, then **completely down**.

The camera takes the picture/pictures after the delay.

Use the same procedure to take a video, but:

- Press the Video mode button .
- Press the Shutter button **completely down**.

NOTE: The video stops when no storage space remains. Only the 2- and 10-second options are available in video mode.



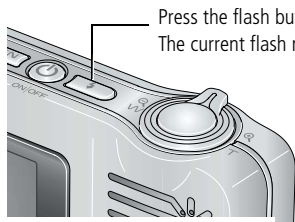

Using the flash





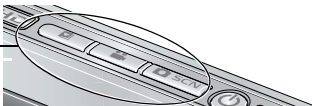

Press the flash button repeatedly to scroll through flash modes.
The current flash mode is shown in the LCD status area.

Flash modes	Flash fires
Auto	When the lighting conditions require it.
Fill	Every time you take a picture, regardless of the lighting conditions. Use when the subject is in shadow or is “backlit” (when light is behind the subject). In low light, hold the camera steady or use a tripod.
Red Eye	In Red Eye flash, you can reduce red eye by using a preflash or by using automatic red eye reduction. To make the camera: <ul style="list-style-type: none"> ■ Preflash, turn the Red Eye Preflash on. (The first flash shrinks the eye pupil to reduce the chance of red eye.) ■ Flash once and automatically remove red eye, turn off the Red Eye Preflash.
Off	Never

Using different modes

Use this mode	For
 SCN Auto	General picture taking—offers an excellent balance of image quality and ease of use.
 SCN Scene	Point-and-shoot simplicity when taking pictures in practically any situation. (See page 15.)
 Video	Capturing video with sound. (See page 4.)
 Favorites	Viewing favorite pictures.
Press a button to choose a mode.	

Use this mode	For
 Landscape	Far-away scenes. The camera uses infinity auto-focus. Auto-focus framing marks are not available in Landscape.
 Macro	Close range. The camera automatically sets the focus distance depending on the zoom position. Use available light instead of flash, if possible.
	Press  until the Macro or Landscape icon appears in the LCD status area.

Using Scene (SCN) modes

Choose a Scene mode—for great pictures in practically any situation!

- 1 Press the Auto/SCN button until the Scene icons appear on the LCD.
- 2 Press ◀/▶ ▲/▼ to view scene mode descriptions.

The date/time and the mode description appear. If the mode description turns off before you finish reading it, press the OK button.

- 3 Press the OK button to choose a Scene mode.

Using camera Help

To better understand each menu option, use camera Help. Press the Menu button, highlight a menu choice, then press the Zoom telephoto (T) button.

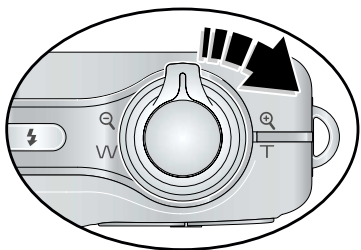

- T** Turn on Help
- ▲/▼ Scroll up/down
- OK** Turn off Help

Understanding the picture-taking icons

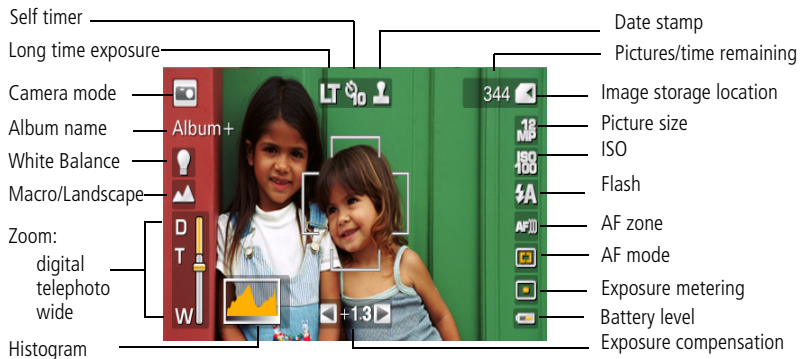

2

Working with pictures/videos

Magnifying a picture

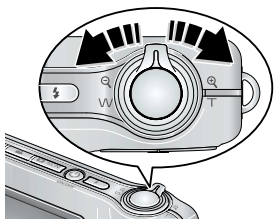

- 1 Press T to magnify 1X–8X.
- 2 Press $\blacktriangle/\blacktriangleright$ $\blacktriangleleft/\blacktriangleleft$ to view other parts of a picture.
- 3 Press OK to return to 1X.

Deleting pictures/videos





- 1 Press the Review button.
- 2 Press $\blacktriangleleft/\blacktriangleleft$ for previous/next picture/video.
- 3 Press the Delete button.
- 4 Follow the screen prompts.

NOTE: To delete protected pictures/videos, remove protection before deleting.

Using the undo delete feature



If you accidentally delete a picture/video, you can use Undo Delete to retrieve it. This feature is only available immediately after you delete a picture/video.

Using the menu button in Review

- 1 Press the Review button, then the Menu button.
- 2 Press  to highlight a tab:
 -  **Review** to view pictures/videos
 -  **Edit** to edit pictures/videos
 -  **Setup** for other camera settings
- 3 Press  to highlight a setting, then press the OK button.
- 4 Highlight an option, then press the OK button.

Using Kodak Perfect Touch technology

Kodak Perfect Touch technology helps ensure better, brighter pictures.

- 1 Press the Review button.
- 2 Press  for previous/next picture.
- 3 Press the Menu button, then  to highlight the Edit  tab. Highlight Perfect Touch tech, then press the OK button.

The enhancement is previewed. Press  to view other parts of the picture.

- 4 Press the OK button. Follow the screen prompts.

Kodak Perfect Touch technology can only be used with pictures, not video.

- Press the Menu button to exit the menu.

Making a picture from a video

You can choose a single frame from a video, then make a picture suitable for a 4 x 6-inch (10 x 15 cm) print.

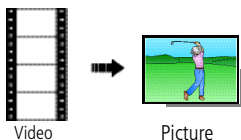

- 1 Press the Review button, then ◀/▶ to find a video.
- 2 Press the Menu button, then ◀/▶ to highlight the Edit  tab. Highlight Make Picture, then press OK.
- 3 Follow the screen prompts.
A picture is created. (The original video is saved.)
 - Press the Menu button to exit the menu.

Making a video action print

From a video, you can make a 4-, 9-, or 16-up picture, suitable for a 4 x 6-inch (10 x 15 cm) print.

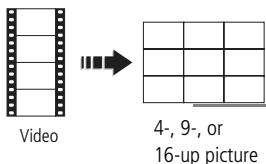

- 1 Press the Review button, then ◀/▶ to find a video.
- 2 Press the Menu button, then ◀/▶ to highlight the Edit  tab. Highlight Action Print, then press OK.
- 3 Highlight an option, then press OK.

A 4-, 9-, or 16-up picture is created. If you have less than 4 or 9 bookmarks, equally-spaced video frames are used.

- Press the Menu button to exit the menu.

Viewing pictures as thumbnails

- 1 Press the Review button.
- 2 Press W to change from single-picture view to multi-up thumbnails.
- 3 Press T to return to single-picture view.
 - To select multiple pictures/videos, see [Selecting multiple pictures/videos](#).
 - Press the Review button to exit Review.

Selecting multiple pictures/videos

Use the multi-select feature when you have two or more pictures/videos to print, copy, delete, etc. (Multi-select is used most effectively in Multi-Up mode, see [Viewing pictures as thumbnails](#).)

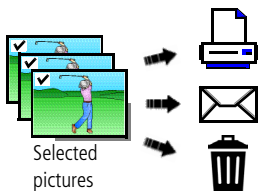

- 1 Press the Review button, then ◀/▶ to find a picture/video.
- 2 Press the OK button to select pictures/videos.

A check mark appears on the picture. You can now print, transfer, delete, etc. the selected pictures. You can press OK a second time to remove a check mark.

3

Solving camera problems

Camera problems

Status	Solution
Camera does not turn on	<ul style="list-style-type: none">■ Make sure the battery is charged and installed correctly (see page 1).■ Turn the camera off, then on again.
Camera does not turn off	
Camera buttons and controls do not function	
Pictures remaining number does not decrease after taking a picture	<ul style="list-style-type: none">■ Continue taking pictures. The camera is operating normally. (The camera estimates the number of pictures remaining after each picture is taken, based on picture size and content.)
Flash does not fire	<ul style="list-style-type: none">■ Check the flash setting, and change as needed (see page 13). <p>NOTE: The flash does not fire in all modes.</p>
The battery does not charge using USB charging	<ul style="list-style-type: none">■ See page 2 or visit www.kodak.com/go/USBcharging.
Battery life is short	<ul style="list-style-type: none">■ Make sure the correct battery type is installed (see page 1).■ Wipe the contacts with a clean, dry cloth before inserting a battery in the camera.■ Insert a new or charged battery (see page 1).



CAUTION:

Do not disassemble this product; there are no user-serviceable parts inside. Refer servicing to qualified service personnel. Kodak AC adapters and battery chargers are intended for indoor use only. The use of controls, adjustments, or procedures other than those specified herein may result in exposure to shock and/or electrical or mechanical hazards. If the LCD breaks, do not touch the glass or liquid. Contact Kodak customer support.

- The use of an accessory that is not recommended by Kodak may cause fire, electric shock, or injury. For approved accessories, visit www.kodak.com/go/accessories.
- Use only a USB-certified computer equipped with a current-limiting motherboard. Contact your computer manufacturer if you have questions.
- If using this product in an airplane, observe all instructions of the airline.
- When removing the battery, allow it to cool; it may be hot.
- Follow all warnings and instructions supplied by the battery manufacturer.
- Use only batteries approved for this product to avoid risk of explosion.
- Keep batteries out of the reach of children.
- Do not allow batteries to touch metal objects, including coins. Otherwise, a battery may short circuit, discharge energy, become hot, or leak.
- Do not disassemble, install backward, or expose batteries to liquid, moisture, fire, or extreme temperature.
- Remove the battery when the product is stored for an extended period of time. In the unlikely event that battery fluid leaks inside the product, contact Kodak customer support.
- In the unlikely event that battery fluid leaks onto your skin, wash immediately with water and contact your local health provider. For additional health-related information, contact your local Kodak customer support.
- Dispose of batteries according to local and national regulations. Visit www.kodak.com/go/kes.
- Do not charge non-rechargeable batteries. Visit www.kodak.com/go/batterytypes.

Limited warranty coverage

Kodak warrants Kodak consumer electronic products and accessories ("Products"), excluding batteries, to be free from malfunctions and defects in both materials and workmanship for one year from the date of purchase. Retain the original dated sales receipt. Proof of the date of purchase will be required with any request for warranty repair. Warranty service is only available from within the country where the Products were originally purchased. You may be required to ship Products, at your expense, to the authorized service facility for the country where the Products were purchased. Kodak will repair or replace Products if they fail to function properly during the warranty period, subject to any conditions and/or limitations stated herein. Warranty service will include all labor as well as any necessary adjustments and/or replacement parts. If Kodak is unable to repair or replace a Product, Kodak will, at its option, refund the purchase price paid for the Product provided the Product has been returned to Kodak along with proof of the purchase price paid. Repair, replacement, or refund of the purchase price are the sole remedies under the warranty. If replacement parts are used in making repairs, those parts may be remanufactured, or may contain remanufactured materials. If it is necessary to replace the entire Product, it may be replaced with a remanufactured Product. Remanufactured Products, parts and materials are warranted for the remaining warranty term of the original Product, or 90 days after the date of repair or replacement, whichever is longer.

Limitations

This warranty does not cover circumstances beyond Kodak's control. This warranty does not apply when failure is due to shipping damage, accident, alteration, modification, unauthorized service, misuse, abuse, use with incompatible accessories or attachments (such as third party ink or ink tanks), failure to follow Kodak's operation, maintenance or repacking instructions, failure to use items supplied by Kodak (such as adapters and cables), or claims made after the duration of this warranty. Kodak makes no other express or implied warranty for this product, and disclaims the implied warranties of merchantability and fitness for a particular purpose. In the event that the exclusion of any implied warranty is ineffective under the law, the duration of the implied warranty will be one year from the purchase date or such longer period as required by law. The option of repair, replacement, or refund is Kodak's only obligation. Kodak will not be responsible for any special, consequential or incidental damages resulting from the sale, purchase, or use of this product regardless of the cause. Liability for any special, consequential or incidental damages (including but not limited to loss of revenue or profit, downtime costs, loss of the use of the equipment, cost of substitute equipment, facilities or services, or claims of your customers for such damages resulting from the purchase, use, or failure of the Product), regardless of cause or for breach of any written or implied warranty is expressly disclaimed.

Your rights

Some states or jurisdictions do not allow exclusion or limitation of incidental or consequential damages, so the above limitation or exclusion may not apply to you. Some states or jurisdictions do not allow limitations on how long an implied warranty lasts, so the above limitation may not apply to you. This warranty gives you specific rights, and you may have other rights which vary from state to state or by jurisdiction.

Outside the United States and Canada

In countries other than the United States and Canada, the terms and conditions of this warranty may be different. Unless a specific Kodak warranty is communicated to the purchaser in writing by a Kodak company, no warranty or liability exists beyond any minimum requirements imposed by law, even though defect, damage, or loss may be by negligence or other act.

Upgrading your software and firmware

Download the latest versions of the software included on the Kodak EasyShare software CD and the camera firmware (the software that runs on the camera). Visit www.kodak.com/go/v1233downloads.

Battery replacement, battery life

Kodak Li-Ion rechargeable digital camera battery KLIC-7004: 220 pictures per charge. Battery life per CIPA testing method. (Approx. number of pictures in Auto mode, using 128 MB SD card.) Actual life may vary based on usage.

Storage capacities

The LCD displays the approximate number of pictures (or minutes/seconds of video) remaining. For average SD card capacities, visit www.kodak.com/go/SDcapacities. Actual storage capacity varies depending on subject composition, card size, and other factors. You may be able to store more or fewer pictures and videos. Favorites take up additional space in internal memory.

Regulatory compliance

FCC compliance and advisory

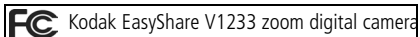

This equipment has been tested and found to comply with the limits for a Class B digital device, pursuant to Part 15 of the FCC Rules. These limits are designed to provide reasonable protection against harmful interference in a residential installation. This equipment generates, uses, and can radiate radio frequency energy and, if not installed or used in accordance with the instructions, may cause harmful interference to radio communications. However, there is no guarantee that interference will not occur in a particular installation. If this equipment does cause harmful interference to radio or television reception, which can be determined by turning the equipment off and on, the user is encouraged to try to correct the interference by one or more of the following measures: 1) reorient or relocate the receiving antenna; 2) increase the separation between the equipment and the receiver; 3) connect the equipment to an outlet on a circuit different from that to which the receiver is connected; 4) consult the dealer or an experienced radio/TV technician for additional suggestions. Any changes or modifications not expressly approved by the party responsible for compliance could void the user's authority to operate the equipment. Where shielded interface cables have been provided with the product or specified additional components or accessories elsewhere defined to be used with the installation of the product, they must be used in order to ensure compliance with FCC regulation.

Australian C-Tick



Canadian DOC statement

Observation des normes-Classe B—Cet appareil numérique de la classe B est conforme à la norme NMB-003 du Canada.

Waste Electrical and Electronic Equipment labeling



In Europe: For human/environmental protection, it is your responsibility to dispose of this equipment at a collection facility established for this purpose (separate from municipal waste). For more information, contact your retailer, collection facility, or appropriate local authorities; or visit www.kodak.com/go/recycle. (Product weight: 150 g.)

VCCI Class B ITE

この装置は、情報処理装置等電波障害自主規制協議会（VCCI）の基準に基づくクラスB情報技術装置です。この装置は、家庭環境で使用することを目的としていますが、この装置がラジオやテレビジョン受信機に近接して使用されると、受信障害を引き起こすことがあります。
取扱説明書に従って正しい取り扱いをして下さい。

Korean Class B ITE

이 기기는 가정용으로 전자파적합 등록을 한 기기로서 주거지역에서는 물론 모든 지역에서 사용할 수 있습니다.

Russian GOST-R



Eastman Kodak Company
Rochester, NY 14650

Фотокамера изготовлена в Китае; остальные элементы -
A10-40 в соответствии с маркировкой.

China RoHS

环保使用期限 (EPUP)

在中国大陆, 该值表示产品中存在的任何危险物质不得释放, 以免危及人身健康、财产或环境的时间期限(以年计)。该值根据操作说明中所规定的产品正常使用而定。

有毒有害物质或元素名称及含量标识表						
部件名称	有毒有害物质或元素					
	铅	汞	镉	六价铬	多溴联苯	多溴二苯醚
数码相机电路板元件	×	○	○	○	○	○
锂电池	×	○	○	○	○	○
交流变压器	×	○	○	○	○	○

○: 表示该有毒有害物质在该部件所有均质材料中的含量均在SJ/T 11363-2006规定的限量要求以下。
 ×: 表示该有毒有害物质至少在该部件的某一均质材料中的含量超出SJ/T 11363-2006规定的限量要求。



USB 数据线



音频/视频电缆

MPEG-4

Use of this product in any manner that complies with the MPEG-4 visual standard is prohibited, except for use by a consumer engaging in personal and non-commercial activities.

Kodak

Eastman Kodak Company

Rochester, New York 14650

© Eastman Kodak Company, 2007

Kodak and EasyShare are trademarks of Eastman Kodak Company.

4J6233_en