

---

# Kodak EasyShare Z1015 IS digital camera



## Extended user guide

[www.kodak.com](http://www.kodak.com)

For interactive tutorials, visit [www.kodak.com/go/howto](http://www.kodak.com/go/howto)

For help with your camera, visit [www.kodak.com/go/z1015support](http://www.kodak.com/go/z1015support)

---

# Kodak

Eastman Kodak Company  
Rochester, NY 14650

© Eastman Kodak Company, 2008

All screen images are simulated.

Kodak, EasyShare, and Perfect Touch are trademarks of Eastman Kodak Company.

P/N 4F8329\_en

## Front view

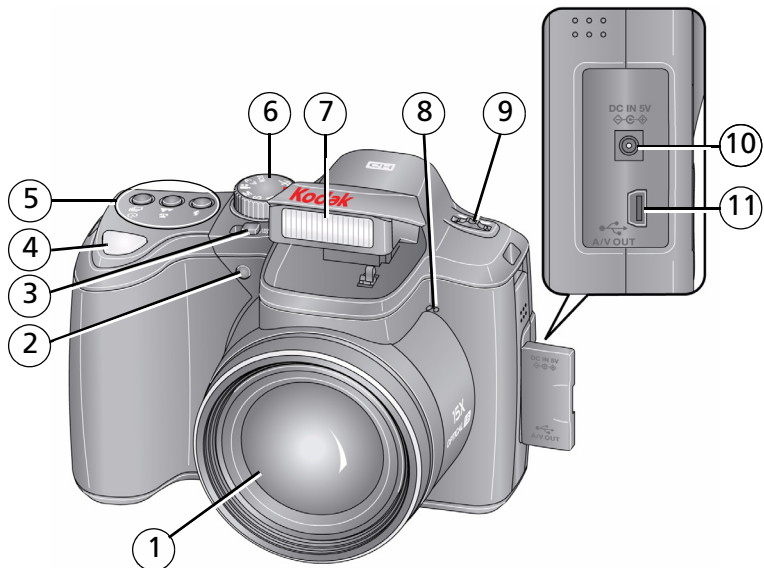

- |   |  |    |  |
|---|--|----|--|
| 1 | Lens   | 7  | Flash                                      |
| 2 | Low-light assist, Self-timer light, Video light  | 8  | Microphone                                 |
| 3 | On/Off switch  | 9  | Log dial (for PASM modes)                  |
| 4 | Shutter button   | 10 | DC-In (5V), for <b>optional</b> AC adapter |
| 5 | <ul style="list-style-type: none"> <li>■ Drive button (Self-timer, Burst)</li> <li>■ Focus button (Close-up/Macro, Landscape, Manual)</li> <li>■ Flash button</li> </ul> | 11 | USB/AV Out                                 |
| 6 | Mode dial  |    |  |

## Back view

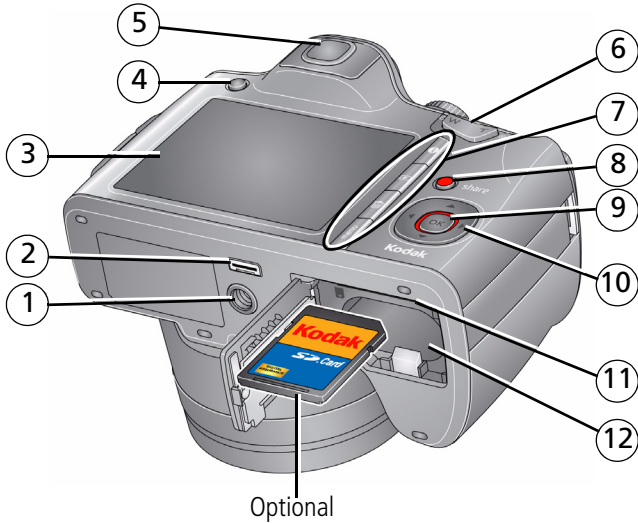

- |   |                                    |    |                                       |
|---|------------------------------------|----|---------------------------------------|
| 1 | Tripod socket                      | 7  | Info/Review/Delete/Menu buttons       |
| 2 | Dock connector                     | 8  | Share button                          |
| 3 | LCD                                | 9  | OK button                             |
| 4 | EVF/LCD button                     | 10 | ▲/▼ ◀/▶                               |
| 5 | EVF (Electronic viewfinder)        | 11 | Slot for <b>optional</b> SD/SDHC card |
| 6 | Zoom (Wide Angle/Telephoto) button | 12 | Battery compartment                   |

---

# Table of contents

<b>1</b>	<b>Setting up your camera</b>	<b>1</b>
	Attaching the strap	1
	Loading the battery	1
	Turning on the camera	4
	Setting the language, date/time	4
	Storing pictures on an optional SD or SDHC card	5
<b>2</b>	<b>Taking pictures/videos</b>	<b>6</b>
	Taking a picture	6
	Capture modes	8
	Using the 15X optical zoom	10
	Using the flash	11
	Using focus modes	12
	Using the self-timer	13
	Using the burst feature	14
	Taking panoramic pictures	15
	Understanding the picture-taking icons	16
<b>3</b>	<b>Working with pictures/videos</b>	<b>17</b>
	Reviewing pictures/videos	17
	Deleting pictures/videos	18
	Using the menu button in Review	20
	Adding sound tags	20
	Cropping pictures	21
	Using Kodak Perfect Touch technology	22
	Using the RAW Develop feature	22
	Editing videos	23
	Running a slide show	25
	Viewing pictures/videos in different ways	28
	Selecting multiple pictures/videos	29
	Copying pictures/videos	29

Understanding the review icons.....	30
<b>4 Doing more with your camera .....</b>	<b>31</b>
Using the Menu button to change settings .....	31
P, A, S, and M modes.....	38
Using exposure compensation with exposure bracketing .....	40
Using the histogram to view picture brightness.....	40
Using the framing grid to compose a picture.....	40
Sharing your pictures.....	41
<b>5 Transferring and printing pictures .....</b>	<b>44</b>
Installing the software.....	44
Transferring pictures with the USB cable.....	45
Printing pictures.....	46
<b>6 Troubleshooting .....</b>	<b>48</b>
<b>7 Getting help .....</b>	<b>52</b>
Getting help from your camera .....	52
Getting help on the Web.....	53
Getting help on the telephone.....	54
<b>8 Appendix .....</b>	<b>55</b>
Camera specifications .....	55
Storage capacities.....	58
Upgrading your software and firmware.....	58
Important safety instructions .....	58
Battery life.....	59
Care and maintenance .....	60
Limited warranty.....	60
Regulatory compliance .....	62

# 1

## Setting up your camera

### Attaching the strap

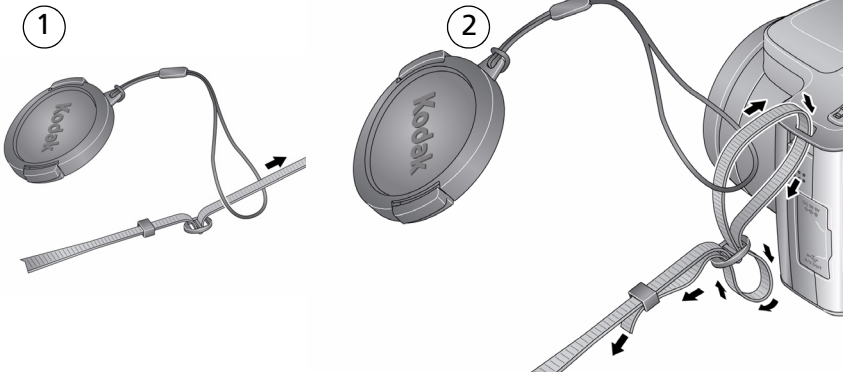

### Loading the battery

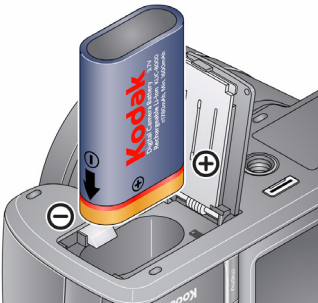

Kodak Li-Ion rechargeable digital camera battery KLIC-8000 (rechargeable)

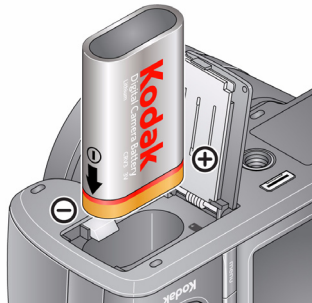

Kodak lithium digital camera battery CRV3 (non-rechargeable)

To charge the KLIC-8000 battery, see [page 2](#).

## Charging the KLIC-8000 battery

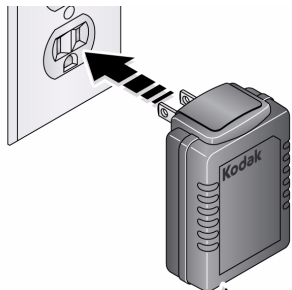

- 1 Turn OFF the camera.
- 2 Connect the cable.

Note: This charger charges the battery; it does **not** power the camera.

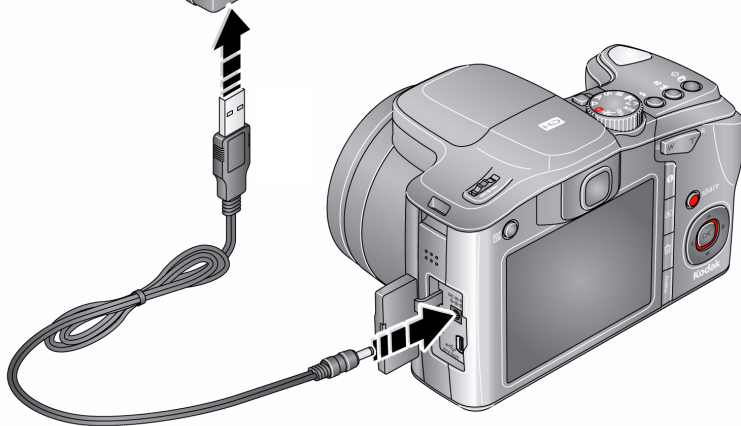

**Important: DO NOT** plug this cable into a computer.

### Charging light

- Blinking: charging
- Steady: finished charging (approximately 3.5 hours)





## Charging the battery using optional accessories

### Kodak 5V AC adapter (2 amp)

To charge the battery, turn off the camera.

To power the camera (without charging the battery), turn on the camera.

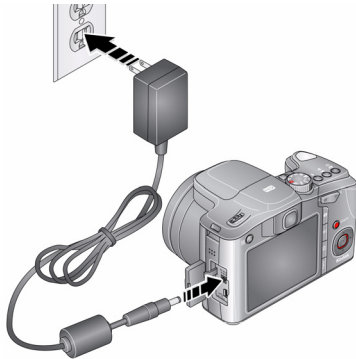

### Kodak EasyShare camera and printer docks

Turn off the camera.



### Kodak USB cable and a USB computer port

Turn off the camera.  
Ensure that the USB cable is connected to a powered USB port and the computer is turned on (not in sleep mode).

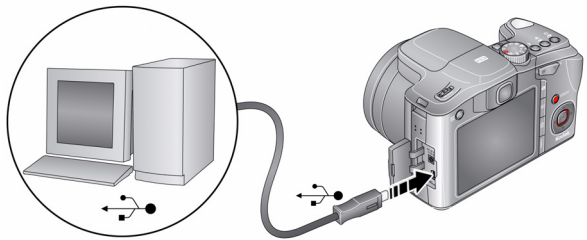

**Purchase accessories**

[www.kodak.com/go/z1015accessories](http://www.kodak.com/go/z1015accessories)

**Learn more about USB charging**

[www.kodak.com/go/USBcharging](http://www.kodak.com/go/USBcharging)

## Turning on the camera

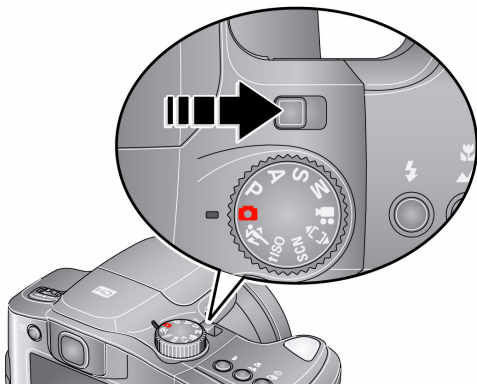

## Setting the language, date/time

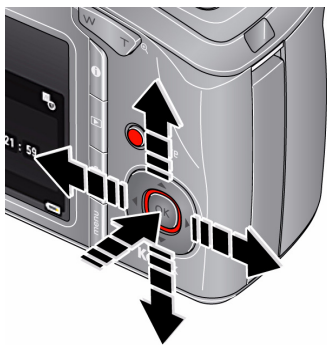

**Language:**

▲/▼ to change

OK to accept

**Date/Time:**

▲/▼ to change

◀/▶ for previous/next field

OK to accept

NOTE: To change the date/time and language in the future, use the Menu button ([see page 37](#)).

## Storing pictures on an optional SD or SDHC card

Your camera has internal memory. You can purchase an SD or SDHC card to store more pictures and videos ([www.kodak.com/go/z1015accessories](http://www.kodak.com/go/z1015accessories)).



- ① Turn off the camera.
- ② Insert or remove the optional card.
- ③ Turn on the camera.



### CAUTION:

A card can only be inserted one way; forcing it may cause damage. Inserting or removing a card when the camera is on may damage the pictures, the card, or the camera.

NOTE: To choose a storage location for pictures and videos, [see page 35](#).

# 2

## Taking pictures/videos

### Taking a picture

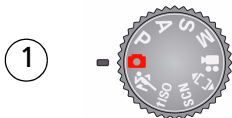

Smart Scene/Smart Capture mode

- 1 Press the EVF/LCD button for:
  - LCD or
  - EVF (electronic viewfinder)
- 2 Press the Shutter button halfway to focus and set exposure.

When the framing marks turn green, press the Shutter button completely down.

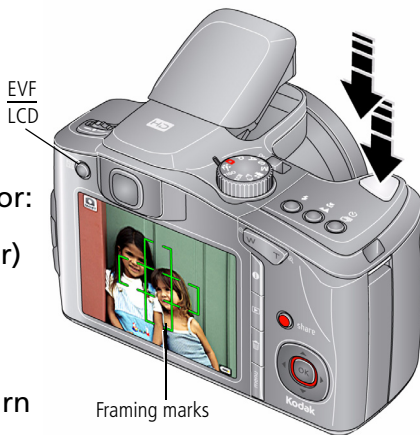

NOTE: After you take a picture, the EVF/LCD displays a quickview.

## Using the framing marks to take pictures

Framing marks indicate the camera focus area. The camera attempts to focus on foreground subjects, even if they're not centered in the scene.

- 1 Press the Shutter button **halfway**.

*If the camera is not focusing on the desired subject, release the Shutter button and recompose the scene.*

- 2 Press the Shutter button **completely down** to take the picture.

NOTE: Multiple framing marks may appear when faces are detected. (The primary face gets a yellow framing mark. To change focus from the selected face to another face, press  $\blacktriangleleft/\blacktriangleright$ .) Framing marks do not appear in all modes.

## Taking a video

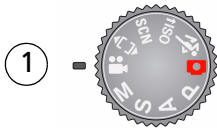

- ① -
- ② Press the EVF/LCD button for:
  - LCD or
  - EVF (electronic viewfinder)
- ③ Press the Shutter button completely down and release. To stop recording, press and release the Shutter button again.





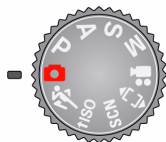

NOTE: After you take a video, the EVF/LCD displays a quickview. To play/pause the video during the quickview, press OK.

## Capture modes



Choose the mode that best suits your subjects and surroundings.

Capture mode	For
 <b>Smart Scene/Smart Capture</b>	<p>General picture taking—it offers excellent image quality and ease of use.</p> <p>NOTE: Smart Scene is the default mode. To change it, <a href="#">see page 32</a>.</p> <ul style="list-style-type: none"> <li>■ Faces are detected.</li> <li>■ The scene is analyzed for other content and for lighting.</li> <li>■ In Smart Capture, Kodak Perfect Touch technology is applied (for better, brighter pictures).</li> </ul> <p>To choose picture size, press the Menu button and choose Picture Size.</p> <ul style="list-style-type: none"> <li>■ 3:2 (the best choice when making 4 x 6 prints)</li> <li>■ 16:9 (wide screen)</li> <li>■ 4:3 (the default setting)</li> </ul>
<b>P, A, S, M</b>	More creative control. (See <a href="#">page 38</a> .) Program, Aperture Priority, Shutter Priority, and Manual mode.
 <b>High ISO</b>	People in low-light scenes.
 <b>Sport</b>	Action pictures.
<b>SCN Scene</b>	Point-and-shoot simplicity when taking pictures under special conditions.
 <b>Panorama</b>	“Stitching” 2 or 3 pictures into 1 panoramic scene. (See <a href="#">page 15</a> .)
 <b>Video</b>	Video with sound. (See <a href="#">page 7</a> .)

## Scene modes

- 1 Turn the Mode dial to Scene **SCN**.
- 2 Press **◀/▶** **▲/▼** to display Scene modes.

NOTE: If the mode description turns off before you finish reading it, press OK.

- 3 Press OK to choose a Scene mode.

<b>SCN mode</b>	<b>For</b>
<b>Portrait</b>	Full-frame portraits of people.
<b>Landscape</b>	Far-away scenes. The camera uses infinity auto-focus. Auto-focus framing marks are not available in Landscape.
<b>Night Portrait</b>	Reducing red eye of people in night scenes or low-light conditions. Place the camera on a flat, steady surface or use a tripod.
<b>Night Landscape</b>	Distant scenery at night. Flash does not fire. Use a tripod.
<b>Snow</b>	Bright snow scenes.
<b>Beach</b>	Bright beach scenes.
<b>Text</b>	Documents. Focus is set to Macro Focus.
<b>Fireworks</b>	Bright, colorful light displays. Flash does not fire. Place the camera on a flat, steady surface or use a tripod.
<b>Flower</b>	Close-ups of flowers or other small subjects in bright light.
<b>Manner/Museum</b>	Quiet occasions, like a wedding or lecture. Flash and sound are off.
<b>Self-Portrait</b>	Close-ups of yourself. Assures proper focus and minimizes red eye.
<b>Children</b>	Pictures of children, indoors.
<b>Stage</b>	People on a lit stage. Fast shutter speed, high ISO. Flash and sounds are off. (Flash setting can be changed.)
<b>Backlight</b>	Subjects that are in shadow or "backlit."
<b>Candle light</b>	Capturing the ambiance of candle light.
<b>Sunset</b>	Capturing the deep hues seen at sunset.

## Using the 15X optical zoom

Use optical zoom to get up to 15X closer to your subject while taking pictures/videos.

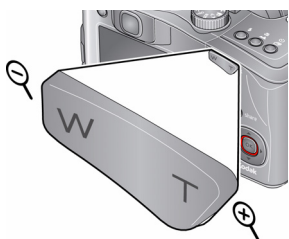

- 1 Use the LCD to frame your subject. For focus distances, see [Camera specifications, page 55](#).
- 2 Press Telephoto (T) or Wide (W) to zoom in/out.
- 3 Take the picture or video.

NOTE: To get a focused picture every time, remember:

- Use the auto focus framing marks, [page 6](#).
- As you zoom in, move away from your subject.

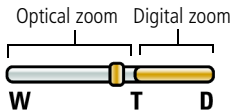

Use digital zoom to get up to 5X beyond optical zoom while taking pictures. Press Telephoto (T) past the maximum optical zoom. Digital zoom is not available in Smart Scene/Smart Capture mode.

NOTE: You may notice decreased image quality when using digital zoom. The slider on the zoom indicator turns red when the picture quality reaches the limit for an acceptable 4 x 6-in. (10 x 15 cm) print.



## Using the flash

Use the flash when you take pictures at night, indoors, or outdoors in heavy shadows. Flash settings are limited in some capture modes.

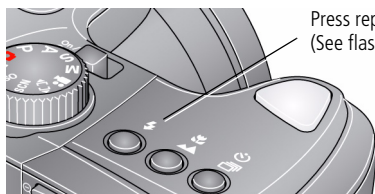

Press repeatedly to scroll through flash modes.  
(See flash modes below.)

Flash modes		Flash fires
<b>Auto</b>		When the lighting conditions require it.
<b>Off</b>		Never.
<b>Fill</b>		Every time you take a picture. Use when the subject is in shadow or is "backlit." In low light, hold the camera steady or use a tripod. NOTE: Not available in Smart Scene/Smart Capture mode. (ISO is set to 400.)
<b>Red Eye</b>	<b>Preflash</b> 	A preflash fires, shrinking the eye pupil, before the picture is taken.
Your camera can correct red-eye using 2 methods (see <a href="#">page 36</a> ).	<b>Digital Correction</b> 	A preflash does not fire; the camera corrects red eye.

### Flash-to-subject distance in Smart Scene/Smart Capture mode

<b>Wide angle</b>	5.0 m (16.4 ft)
<b>Telephoto</b>	3.2 m (10.5 ft)

## Using focus modes





- In most Still modes, press the Focus / button:
  - Once for Macro (close-up)
  - Again for Landscape (infinity)
  - Again for Manual Focus
  - Again to return to normal Auto Focus
- Compose the scene. Press the Shutter button **halfway**, then completely down.

Icon	Mode	Description
(none)	<b>Normal AF</b>	Focus setting for general picture-taking.
	<b>Macro</b>	To gain sharpness and detail in pictures at close range. Use available light instead of flash, if possible. Camera automatically sets the focus distance depending on the zoom position: 0.1–1.0 m (0.3–3.3 ft) @ wide macro 0.7–3.5 m (2.3–11.5 ft) @ telephoto macro
	<b>Landscape</b>	To gain sharpness of distant scenes. Camera uses infinity auto-focus. Auto-focus framing marks are not available in Landscape.
<b>MF</b>	<b>Manual Focus</b>	The focus icon shows the direction and distance of the focus (to infinity). Press / to view 2X magnification of the central area of focus. During magnification, press / to adjust focal length. (Framing marks are off in this mode.)

## Using the self-timer

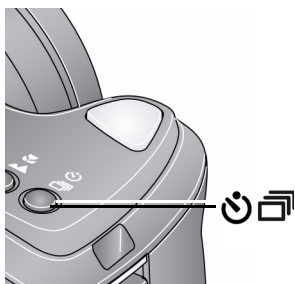
Use the self-timer when you want to be included in a picture, or to ensure a steady Shutter button press.



- 1 Place the camera on a tripod or flat surface.
- 2 In most Still modes, press the Self-timer/Burst button :
  - Once for a 10-second delay (so you have time to get into the scene)
  - Again for a 2-second delay (for a steady, auto-shutter release on a tripod)
  - Again for 2-shot (one picture taken after 10 seconds; another, 8 seconds later)
- 3 Compose the scene. Press the Shutter button **halfway**, then **completely down** to take pictures.

*The picture is taken after the delay.*

To cancel the Self-timer during countdown, press the Self-timer/Burst button , or press the Shutter button completely down.

**Use the same procedure to use the self-timer in Video mode, but:**

- Turn the Mode dial to Video .
- Press the Shutter button completely down.

NOTE: The video stops when no storage space remains. Only the 2- and 10-second options are available in video mode.

## Using the burst feature

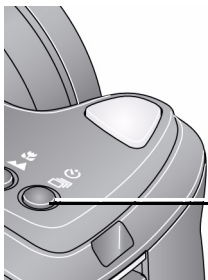



- 1 In most Still modes, press the Self-timer/Burst button . (See burst modes below.)

NOTE: Burst is unavailable in Portrait, Night Portrait, Night Landscape, Backlight, Fireworks, and Panorama modes.

- 2 Press the Shutter button **halfway** to focus and set exposure.
- 3 Press the Shutter button **completely down and hold it** to take pictures.

*The camera stops taking pictures when you release the Shutter button, when the pictures are taken, or when there is no more storage space.*

NOTE: You can delete pictures in Review (see [page 18](#)).



Mode	Icon	Description	Purpose
First Burst		Camera takes up to 3 pictures in Smart Scene/Smart Capture mode while the Shutter button is pressed.	Capture an expected event.  <b>Example:</b> A person swinging a golf club.
Last Burst		Camera takes up to 30 pictures while the Shutter button is pressed. When the Shutter button is released, only the last 3 pictures are saved.	Capture an event when the precise timing is uncertain.  <b>Example:</b> A child blowing out birthday candles.

## Taking panoramic pictures

Use panorama to “stitch” up to 3 pictures into a panoramic scene.

**NOTE:** For best results, use a tripod. Individual pictures are not saved, even if panorama capture is cancelled before stitching occurs. (Exposure Compensation, White Balance, Exposure Metering, AF Zone, AF Control, Color Mode, and Sharpness are set with the first picture. The flash is set to Off.)

You can use the self-timer (2- and 10-second delays) while taking panoramic pictures. [See page 13.](#)

- 1 Turn the Mode dial to Panorama .
- 2 Press /  to highlight Panorama Left-Right or Panorama Right-Left (depending on the direction you want to pan), then press OK.
- 3 Take the first picture.

*After a quickview, the LCD displays the liveview and an “overlay” from the first picture.*

- 4 Compose the second picture. Make the overlay from the first picture cover the same portion in the new picture.
- 5 If you are taking only 2 pictures, press OK to stitch them together.

*After you take 3 pictures, the pictures are automatically stitched together.*

Take 2 or 3 pictures.



Get 1 panoramic picture.



## Understanding the picture-taking icons

Status icons indicate mode, feature, and camera status.

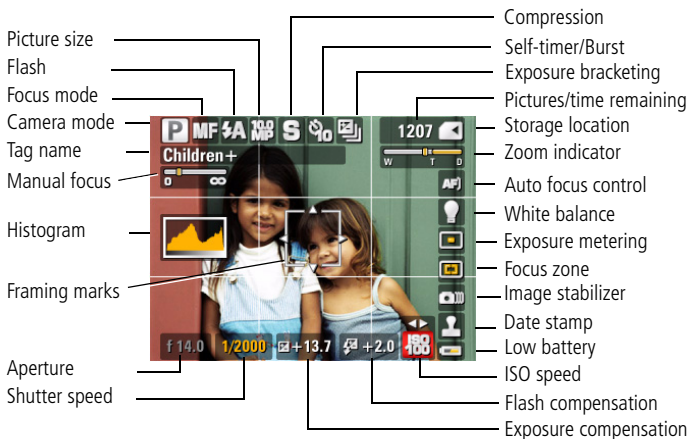

# 3

## Working with pictures/videos

### Reviewing pictures/videos



Press the Review button to view and work with your pictures/videos. Press Review again to exit.



- 1 Press the Review button.
  - 2 Press  to view previous/next picture/video.
- NOTE: Pictures taken at the 3:2 and 16:9 aspect ratios do not fill the LCD.

### Magnifying a picture during review



-  magnify 2X - 8X
-  view other parts of the picture
- OK or W return to 1X

NOTE: If you press the W button while at 1X, the view changes from single-picture to multi-up thumbnails. (See [page 28.](#))

## Playing a video



- 1 Press the Review button.
- 2 Press ◀/▶ to locate previous/next video.
- 3 Press ▼ to play a video.
  - Press ▲/▼ during playback to adjust the volume.
  - Press OK to pause/resume. Press ◀/▶ during pause to go to previous/next frame.
  - Press ▶ during playback to play at 2X speed; press again for 4X. Press ◀/▶ during 4X to jump to a bookmark. (See [page 24](#).)
  - Press ◀ during playback to reverse at 2X speed; press again for 4X.

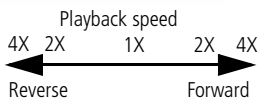

## Viewing picture/video information

- 1 Press the Review button.
- 2 Repeatedly press the Info ⓘ button to turn on/off status icons and picture/video info.

## Deleting pictures/videos



- 1 Press the Review button.
- 2 Press ◀/▶ to find a picture/video.
- 3 Press the Delete button.
- 4 Follow the screen prompts.





## Using the undo delete feature

If you accidentally delete a picture/video, use Undo Delete to retrieve it. This feature is available immediately after you delete a picture/video in Review mode (when the Undo Delete option appears).

- 1 Press  to highlight Undo Delete.
- 2 Press OK.  
The deleted picture/video appears.
- 3 Select Exit to exit the Delete menu.

## Protecting pictures/videos from deletion

- 1 Press the Review button.
- 2 Press  to find a picture/video.
- 3 Press the Menu button.
- 4 Press  to highlight Protect, then press OK.  
*The Protect icon  appears with the protected picture/video.*
  - Press the Menu button to exit the menu.



### CAUTION:

**Formatting internal memory or an SD or SDHC card deletes all (including protected) pictures/videos. (Formatting internal memory also deletes email addresses.)**

## Using the menu button in Review

- 1 Press the Review button, then the Menu button.
- 2 Press ◀/▶ to choose a tab:
  - **Review** to view pictures/videos
  - **Edit** to edit pictures/videos
  - **Setup** for other camera settings
- 3 Press ▲/▼ to highlight a setting, then press OK.
- 4 Choose an option, then press OK.

**IMPORTANT:** *Your camera offers an on-board Help system. To get the most from your camera, see [page 52](#).*

## Adding sound tags

You can add a recorded voice or sound tag (up to 1 minute long) to a picture.

NOTE: Only one sound tag can be added to each picture (not to videos).

### Recording a sound tag

- 1 Press the Review button, then ◀/▶ to find a picture.
- 2 Press the Menu button, then ◀/▶ to highlight the Edit tab.
- 3 Press ▲/▼ to highlight Sound Tag, then press OK.
- 4 Follow the screen prompts.

*The sound tag is applied to your picture.*

- Press the Menu button to exit the menu.

## Playing a sound tag

- 1 Press the Review button, then ◀/▶ to find a picture with the prompt, "Press "Down" button to play sound tag."
- 2 Press ▼ to play the sound tag.
- 3 Press ▲/▼ to adjust the volume.

## Cropping pictures

You can crop a picture so that only the desired portion of the picture remains. (You cannot crop these pictures: panoramic, video action prints, pictures from a video, or pictures that are already cropped.)

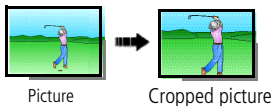

- 1 Press the Review button, then ◀/▶ to find a picture.
- 2 Press the Menu button, then ◀/▶ to highlight the Edit tab.
- 3 Press ▲/▼ to highlight Crop. Press OK.
- 4 Press Telephoto (T) to zoom in, or ◀/▶ ▲/▼ to move the crop box. Press OK.
- 5 Follow the screen prompts.

*The picture is cropped, the original saved. (Cropped pictures cannot be cropped again.)*

- Press the Menu button to exit the menu.

## Using Kodak Perfect Touch technology

Kodak Perfect Touch technology helps ensure better, brighter pictures. Perfect Touch technology is automatically applied to pictures taken in Smart Scene/Smart Capture mode. (You cannot apply Perfect Touch to videos or pictures to which Perfect Touch technology is already applied.)

- 1 Press the Review button, then ◀/▶ to find a picture.
  - 2 Press the Menu button, then ◀/▶ to highlight the Edit tab.
  - 3 Press ▲/▼ to highlight Perfect Touch tech. Press OK.  
*A preview is shown in a split screen. Press ◀/▶ to view other parts of the picture.*
  - 4 Press OK. Follow the screen prompts to replace the original picture or to save the enhanced picture as a new one.
- Press the Menu button to exit the menu.

## Using the RAW Develop feature

In P, A, S, and M modes, you can take pictures as the RAW file type. The RAW Develop feature lets you develop, edit, and save RAW files as Fine, Standard, or Basic. (The original RAW file is preserved.) You can then edit the new file's picture size, quality, exposure compensation, color mode, sharpness, and white balance.

- 1 Press the Review button, then ◀/▶ to find a picture.
- 2 Press the Menu button, then ◀/▶ to highlight the Capture + tab.
- 3 Press ▲/▼ to highlight RAW File Develop, then press OK.
- 4 Press ▲/▼ to highlight options and to make adjustments:
  - Picture Quality
  - File Type
  - Exposure Compensation
  - Color Mode
  - Sharpness
  - White Balance
- 5 When finished, press ▲/▼ to highlight Develop RAW File, then press OK.

## Editing videos

### Making a picture from a video

You can choose a single frame from a video, then make a picture suitable for printing.

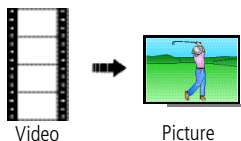

- 1 Press the Review button, then ◀/▶ to find a video.
- 2 Press the Menu button, then ◀/▶ to highlight the Edit tab.
- 3 Press ▲/▼ to highlight Make Picture, then press OK.
- 4 Press OK to play the video. (Press OK to pause). Press ◀/▶ to navigate through video frames.
- 5 During play or pause, press ▼ to make a picture.  
*A picture is created. (The original video is saved.)*
  - Press the Menu button to exit the menu.

### Trimming a video

You can delete an unwanted portion from the beginning or end of a video.

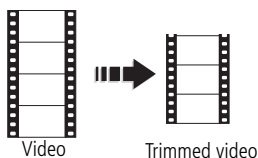

- 1 Press the Review button, then ◀/▶ to find a video.
- 2 Press the Menu button, then ◀/▶ to highlight the Edit tab.
- 3 Press ▲/▼ to highlight Trim. Press OK.
- 4 Follow the screen prompts.  
*The video is trimmed. (You can save it as a new video or replace the original.)*
  - Press the Menu button to exit the menu.

## Using video bookmarks

You can set bookmarks at interesting places in your video, then jump from one bookmark to another.

### Setting bookmarks

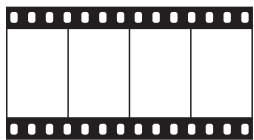

- 1 Press the Review button, then ◀/▶ to find a video.
- 2 Press the Menu button, then ◀/▶ to highlight the Edit tab.
- 3 Press ▲/▼ to highlight Bookmark, then press OK. Highlight Create/Edit, then press OK.
- 4 Press ▼ to add bookmarks. When finished adding up to 9 bookmarks, press ▲.
  - Press the Menu button to exit the menu.

### Using bookmarks

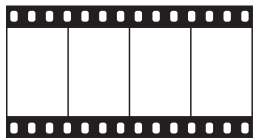

- 1 Press the Review button, then ◀/▶ to find a video.
- 2 Press ▼ to play the video. To jump to the first bookmark, press and hold ◀/▶ for 4 seconds while the video is playing.
  - After you jump to a bookmark, press ◀/▶ to jump to other bookmarks.
  - To view all bookmarked video frames, press the Zoom wide angle (W) button. To return to normal view, press the telephoto (T) button.

## Making a video action print

From a video, you can make a 4-, 9-, or 16-up picture, suitable for a 4 x 6-inch (10 x 15 cm) print.

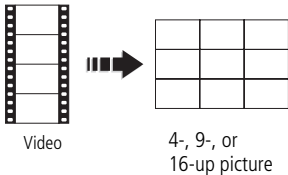

- 1 Press the Review button, then ◀▶ to find a video.
- 2 Press the Menu button, then ◀▶ to highlight the Edit tab.
- 3 Press ▲/▼ to highlight Action Print. Press OK. Choose an option, then press OK:

- Auto options: The camera includes the first and last frames, then 2, 7, or 14 equally spaced frames.
- Manual: You choose the first and last frames; the camera chooses 2, 7, or 14 equally spaced frames.
- Full Manual: You choose the all the frames.
- Use Bookmarks: Bookmarked frames are used.

*A 4-, 9-, or 16-up picture is created. If you have less than 4 or 9 bookmarks, equally-spaced video frames are used.*

- Press the Menu button to exit the menu.

## Running a slide show

Use Slide Show to display your pictures/videos on the LCD.

- 1 Press the Review button, then the Menu button.
- 2 Press ▲/▼ to highlight Slide Show, then press OK.
- 3 Press ▲/▼ to highlight Begin Show, then press OK.

*The slide show begins.*

- To interrupt the Slide Show, press OK.

## Changing the slide show display interval

You can set the display interval from 3–60 seconds.

- 1 On the Slide Show menu, press ▲/▼ to highlight Interval, then press OK.
- 2 Select a display interval.  
To scroll through the seconds quickly, press and hold ▲/▼.
- 3 Press OK.

*The interval setting remains until you change it.*

## Running a continuous slide show loop

When you turn on Loop, the slide show is continuously repeated.

- 1 On the Slide Show menu, press ▲/▼ to highlight Loop, then press OK.
- 2 Press ▲/▼ to highlight On, then press OK.
- 3 Press ▲/▼ to highlight Begin Show, then press OK.

*The slide show repeats until you press OK or battery power is exhausted.*

## Creating a multimedia slide show

Multimedia Slide Show lets you create and save a slide show.

- 1 Press the Review button.
- 2 Select 2-20 pictures (see [page 29](#)).
- 3 Press the Menu button. Press ▲/▼ to highlight Multimedia Slide Show, then press OK.
- 4 Press ▲/▼ to highlight a choice (Begin Show, Music, Effect, Play Order), then press OK. Begin Show creates a multimedia slide show file.

*Each picture is displayed once. To interrupt the slide show, press OK. After the slide show plays, you may save or modify it.*



## Displaying pictures/videos on a television

You can display pictures/videos on a television, computer monitor, or any device equipped with a video input. To connect the camera to a television, use an A/V cable (may be sold separately).

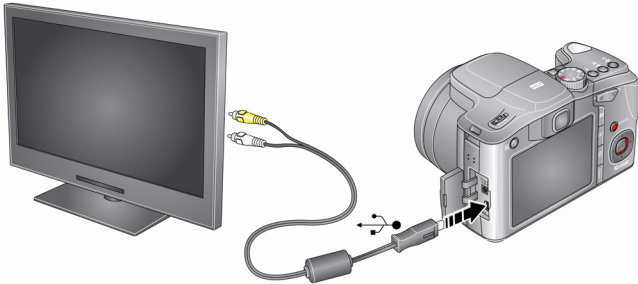

NOTE: With a direct camera-to-television connection, video playback is limited to VGA and QVGA.

## Viewing pictures/videos in different ways

### Viewing as thumbnails (multi-up)

- 1 Press the Review button.
- 2 Press the Wide Angle (W) button to change from single-picture view to multi-up thumbnails.
- 3 Press Telephoto (T) to return to single-picture view.
  - To select multiple pictures/videos, see [page 29](#).
  - Press the Review button to exit Review.

### Searching pictures by date, favorites, or other tag

If you have many pictures on your camera or card, you can sort them so that only some are visible at a time. You can sort by the date a picture was taken or—if you've tagged pictures with a favorites tag or a tag that you created—you can sort by tag.

- 1 Press the Review button, then the Menu button.
- 2 Press **▲/▼** to highlight Search, then press OK.
- 3 Press **◀/▶** to highlight the Date, Favorite, or Tag tab, then **▼** to select a folder.
- 4 Press **◀/▶** to highlight a folder, then press OK. (If you chose a Month/Year folder, press OK to see the Day folders.) When you are finished choosing tabs and folders, highlight Exit and press OK.
- 5 To see the results of your search, highlight Save, then press OK.

*Pictures are displayed in multi-up view. Press **◀/▶** **▲/▼** to view them. Press the Telephoto (T) button to view the picture full-screen. Press the Wide Angle (W) button to return to multi-up view. Search results are kept until you exit Review.*

- Press the Review button to exit Review.
- For more about tags, see [page 43](#).
- To select multiple pictures/videos, see [page 29](#).

## Selecting multiple pictures/videos

Use the multi-select feature when you have two or more pictures/videos to print or delete. (Multi-select can also be used in Multi-Up mode, [page 28](#).)

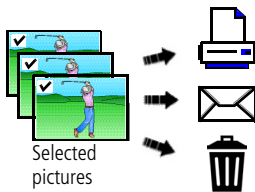

- 1 Press the Review button, then ◀/▶ to find a picture/video.
- 2 Press OK to select pictures/videos.

*A check mark appears on the picture. You can now print, email, or delete the selected pictures. You can press OK a second time to remove a check mark.*

## Copying pictures/videos

You can copy pictures/videos from a card to internal memory or from internal memory to a card.

NOTE: Before you copy, make sure that a card is inserted in the camera.

### Copy pictures/videos:

- 1 Press the Review button, then the Menu button.
- 2 Press ▲/▼ to highlight Copy, then press OK.
- 3 Press ▲/▼ to highlight an option, then press OK.

NOTE: Pictures/videos are copied, not moved. To remove pictures/videos from the original location after copying, delete them (see [page 18](#)).

## Understanding the review icons

### Pictures

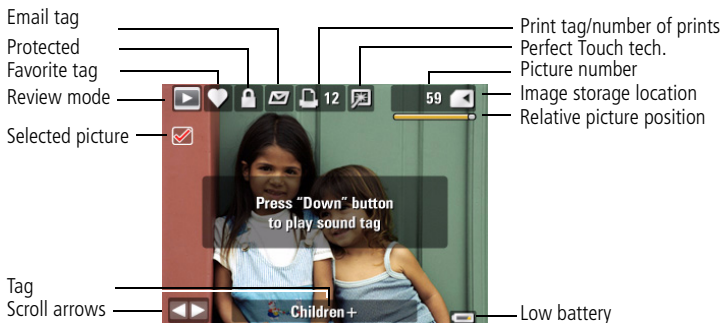

### Videos

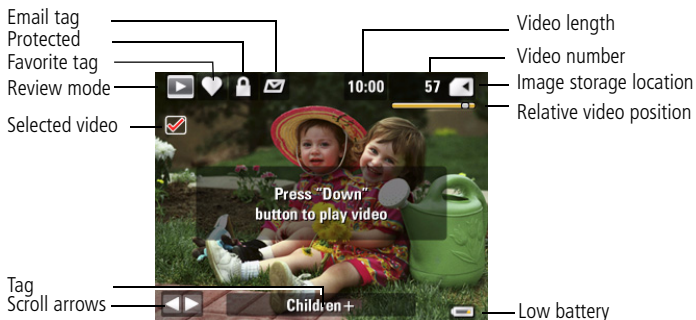

# 4

## Doing more with your camera

**IMPORTANT:** *Your camera offers an on-board Help system. To get the most from your camera, see [page 52](#).*

### Using the Menu button to change settings

**NOTE:** Some settings remain until you change them; others remain until you turn off the camera. Some capture modes offer limited settings. information about camera settings and options.

- 1 Press the Menu button.
- 2 Press ◀/▶ to highlight a menu tab:
  - **Capture** for the most common picture-taking settings.
  - **Capture +** for more advanced picture-taking settings.
  - **Setup** for other camera settings.
- 3 Press ▲/▼ to highlight a setting, then press OK.
- 4 Choose an option, then press OK.

Press Menu, ▲/▼, and OK to access settings	Capture Options	
Picture Size (in Smart Scene/Smart Capture mode) Choose a picture resolution. For more about Smart Scene/Smart Capture mode, see <a href="#">page 8</a> .	10.0 MP (4:3)	3.8 MP (16:9)
	8.9 MP (3:2)	3.1 MP (4:3)
	7.5 MP (16:9)	2.8 MP (3:2)
	5.0 MP (4:3)	2.4 MP (16:9)
	4.5 MP (3:2)	

**Press Menu, ▲/▼, and OK to access settings**

**Capture Options**

**Picture Size (in all other still capture modes)**

Choose a picture resolution.

**10.0 MP (4:3)**

**8.9 MP (3:2)**

**7.5 MP (16:9)**

**5.0 MP (4:3)**

**3.1 MP (4:3)**

**2.2 MP (3:2)**

**2.1 MP (16:9)**

**1.2 MP (4:3)**

**Video Size**

Available only in Video mode.

**1280 x 720 (HD720p) HQ**—HDTV format; uses the least compression and gives the highest video quality. (29-min. maximum video. Orientation sensor is disabled.)

**640 x 480 HQ**—medium quality and file size. (80-min. maximum video.)

**320 x 240**—lowest quality; smallest file size. (80-min. maximum video.)

**Capture Mode**

Choose Smart Scene or Smart Capture.

Available only in Smart Scene/Smart capture mode.

**Smart Scene**—for faster camera performance.

**Smart Capture**—for auto-enhancement of pictures.

**Picture Quality**

Choose how much compression is applied to pictures.

Not available Smart Scene/Smart Capture mode.

**Fine**—least compression; best quality, and largest file size.

**Standard**—medium compression; medium quality, and medium file size.

**Basic**—most compression; lowest quality, and smallest file size.

**RAW**—unprocessed image data in its original state (to which white balance, contrast, etc. have not been applied). You can use the Raw Develop feature to create a JPG copy for printing ([see page 22](#)).

Press Menu, ▲/▼, and OK to access settings

Capture Options

**Color Mode**

Choose color tones for pictures.

**High Color**

**Natural Color**

**Low Color**

**Black & White**

**Sepia**

NOTE: EasyShare software also lets you change a color picture to black-and-white or sepia.

**AF Control**

Choose an auto-focus setting.

Not available Smart

Scene/Smart Capture mode.

**Continuous AF**—because the camera is always focusing, there is no need to press the Shutter button halfway down to focus.

**Single AF**—uses TTL-AF (through-the-lens auto focus) when the Shutter button is pressed halfway down.

**Using the Capture + menu**

NOTE: Some capture modes offer limited settings.

Press Menu, ◀/▶, ▲/▼, and OK to access settings

Capture + Options

**Face Detect Capture**

Faces are given focus priority. The AF Zone and Exposure Metering settings are ignored.

Not available in Panorama SCN mode. Always on in Smart Scene/Smart Capture mode.

**On**

**Off**

Press Menu, , , , , and OK to access settings

## Capture + Options

### White Balance

Choose your lighting condition. Available only in PASM and Panorama modes.

**Auto**—automatically corrects white balance. Ideal for general picture taking.

**Daylight**—for pictures in natural lighting.

**Tungsten**—corrects the orange cast of household light bulbs. Ideal for indoor pictures under tungsten or halogen lighting without flash.

**Fluorescent**—corrects the green cast of fluorescent lighting. Ideal for indoor pictures under fluorescent lighting without flash.

**Open Shade**—for pictures in shade in natural lighting.

### Exposure Metering

Evaluate light levels at specific areas of a scene.

Available only in PASM and Panorama modes.

NOTE: If Face Detection Capture is turned on, faces are given exposure priority.

**Multi-pattern**—evaluates lighting conditions throughout the image to give an optimum picture exposure. Ideal for general picture taking.

**Center-weight**—evaluates the lighting conditions of the subject centered in the LCD. Ideal for backlit subjects.

**Spot**—similar to Center-weight, except the metering is concentrated on a smaller area of the subject centered in the LCD.

### AF Zone





Select a large or concentrated area of focus.

Available only in PASM and Panorama modes.





NOTE: If Face Detection Capture is turned on, faces are given focus priority.

**Multi-zone**—evaluates 5 zones to give an even picture focus. Ideal for general picture taking.

**Center-zone**—evaluates the small area centered in the LCD. Ideal when precise focus of a specific area in the picture is needed.





**Selectable Zone**—press , , ,  to move the focus brackets and choose an auto focus zone.







Press Menu,  ,  ,  ,  , and OK to access settings	Capture + Options
<p><b>Exposure Bracketing Interval</b></p> <p>Choose the difference in exposure compensation while using exposure bracketing.</p> <p>Available only in PASM mode.</p>	<p><b>Off</b></p> <p><b>+/- 0.3 EV</b></p> <p><b>+/- 0.7 EV</b></p> <p><b>+/- 1.0 EV</b></p> <p>See <a href="#">page 40</a>.</p>
<p><b>Sharpness</b></p> <p>Control picture sharpness.</p> <p>Available only in PASM and Panorama modes.</p>	<p><b>High</b></p> <p><b>Normal</b></p> <p><b>Low</b></p>

## Using the Setup menu

NOTE: Some capture modes offer limited settings.

Press Menu,  ,  ,  ,  , and OK to access settings	Setup Options
<p><b>LCD Brightness</b></p>	<p><b>1, 2, 3, 4, 5</b></p>
<p><b>Image Storage</b></p> <p>Choose a storage location for pictures/videos.</p>	<p><b>Auto</b>—the camera uses the card if one is in the camera. If not, the camera uses internal memory.</p> <p><b>Internal Memory</b>—the camera uses internal memory, even if a card is installed.</p>
<p><b>Set Tag</b></p> <p>Assign tag names to pictures/videos. Select tag name(s) before you take pictures or videos. Then, new pictures/videos are assigned that tag name(s).</p>	<p><b>Clear All</b></p> <p><b>Add Tag</b></p> <p><b>Delete Tag</b></p> <p><b>Exit</b></p> <p><b>Tag Name 1</b></p> <p><b>Tag Name 2</b></p> <p>See <a href="#">page 43</a>.</p>

Press Menu,  ,  ,  ,  , and OK to access settings	Setup Options
<b>Capture Frame Grid</b> Use the frame grid to divide the LCD screen into thirds, vertically and horizontally.	<b>On</b> <b>Off</b>
<b>Date Stamp</b> Imprint the date on pictures.	<b>On</b> <b>Off</b>
<b>Image Stabilizer</b> Reduce the chance of blurry pictures.	<b>On</b> —Stabilization occurs when the Shutter button is pressed halfway down. <b>Off</b>
<b>Red-eye Reduction</b> The Red-eye flash fires automatically before a picture is taken.	<b>Preflash</b> —The flash fires to reduce the chance of red-eye. <b>Digital correction</b> —The camera digitally corrects red-eye after a picture is taken.
<b>Quickview</b> Show a picture/video as soon as it is taken.	<b>On</b> <b>Off</b>
<b>Advanced Digital Zoom</b> Zoom using optical, then digital zoom. Not available in Smart Scene/Smart Capture mode.	<b>Continuous</b> —Zooming is continuous between optical and digital zoom. <b>Pause</b> —Zooming pauses at the optical zoom maximum. To use digital zoom, release then press the Telephoto (T) zoom button. <b>None</b> —Digital zoom is off.
<b>Orientation Sensor</b> Orient pictures so that they are displayed with the correct side up.	<b>On</b> <b>On Transfer</b> <b>Off</b>
<b>Camera Sounds</b> Choose sound effects.	<b>Theme</b> —applies the same sound effect set to all functions. <b>Individual</b> —choose a sound effect for each function.

Press Menu, ◀/▶, ▲/▼, and OK to access settings

## Setup Options

<b>Sound Volume</b>	<p>Off</p> <p>High</p> <p>Medium</p> <p>Low</p>
<b>Date &amp; Time</b>	See <a href="#">page 4</a> . The format chosen is used for all date/time features.
<p><b>Auto Power Off</b></p> <p>Choose inactivity time until camera turns off.</p>	<p>10 minutes</p> <p>5 minutes</p> <p>3 minutes</p> <p>1 minute</p>
<p><b>Video Out</b></p> <p>Choose the regional setting for connecting to a television or other external device.</p>	<p>NTSC—used in North America and Japan.</p> <p>PAL—used in Europe and China.</p>
<b>Language</b>	See <a href="#">page 4</a> .
<b>Reset Camera</b>	Reset all camera settings to their defaults.
<p><b>Format</b></p> <p> <b>CAUTION:</b>  <b>Formatting deletes all pictures/videos, including those that are protected.</b></p>	<p><b>Memory Card</b>—deletes everything on the card; formats the card.</p> <p><b>Cancel</b>—exits without making a change.</p> <p><b>Internal Memory</b>—deletes everything in internal memory including email addresses and tag names; formats the internal memory.</p>
<b>About</b>	View camera information.

## P, A, S, and M modes

Use these modes when you want more control over your camera and pictures.

Mode	When to use	Press Jog dial to control
<b>P</b>	<b>Program mode</b> offers the ease of auto shooting with full access to all menu options. The camera automatically sets the shutter speed and aperture (f-stop) based on the scene lighting.	Exposure compensation (how much light enters the camera), flash compensation, and ISO speed
<b>A</b>	<b>Aperture Priority</b> mode controls depth of field (the range of sharpness). The aperture setting may be affected by optical zoom.	Aperture, exposure compensation, flash compensation, and ISO speed
<b>S</b>	<b>Shutter Priority</b> mode prevents blur when your subject is moving. The camera automatically sets the aperture for proper exposure. (To prevent blur, use a tripod for slow shutter speeds.)	Shutter speed, exposure compensation, and flash compensation
<b>M</b>	<b>Manual</b> mode offers the highest level of creative control. (To prevent blur, use a tripod for slow shutter speeds.)	Aperture, shutter speed, flash compensation, and ISO speed

Jog dial:

- 1 Turn to access a setting.
- 2 Press to unlock the setting.
- 3 Turn to change the setting.
- 4 Press to lock the setting.

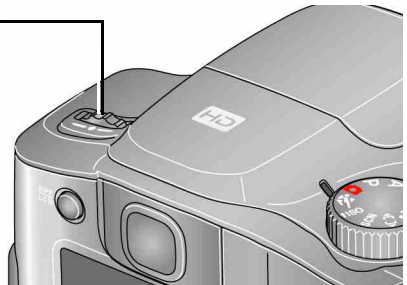

NOTE: Settings you change in P, A, S, or M modes apply only to pictures taken in those modes. The settings, including Flash, are maintained for P, A, S, and M modes—even when you change modes or turn off the camera. Use Reset Camera ([see page 37](#)) to reset P, A, S, or M mode to its default setting.

## Changing P, A, S, or M mode settings

PASM modes control the aperture (f-number, also known as f-stop), shutter speed, exposure compensation, flash compensation, and ISO. Use the Menu button to control all other settings.

- 1 Turn the Mode dial to P, A, S, or M.
- 2 Jog dial: Turn to access a setting. Press to unlock the setting. Turn to change the setting. Press to lock the setting. (See [page 38](#).)

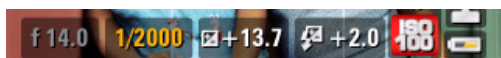

**Note:** A yellow setting indicates possible unsatisfactory results. (However, you can still take the picture.)

ISO  
Flash compensation  
Exposure compensation  
Shutter speed  
Aperture

**ISO**—adjust the camera’s sensitivity to light. Higher ISO indicates greater sensitivity.

**NOTE:** A higher ISO may produce unwanted “noise” in a picture. ISO 3200 and 6400 available only in 3.1 MP and lower picture sizes. (In Smart Scene/Smart Capture mode, ISO 1600 is the maximum.)

**Flash Compensation**—adjust flash brightness.

**Exposure Compensation**—adjust the exposure. If the picture is too light, decrease the setting; if it’s too dark, increase the setting.

**Shutter speed**—control how long the shutter stays open. (Use a tripod for slow shutter speeds.)

**Aperture**—(also known as f-stop) control the size of the lens opening, which determines the depth of field.

- Smaller f-stop numbers indicate a larger lens opening; good for low-light.
- Larger f-stop numbers indicate a smaller lens opening; keeps the main subject sharp; good for landscapes and well-lit conditions.

## Using exposure compensation with exposure bracketing

In PASM modes, you can use exposure compensation in conjunction with exposure bracketing to get the best exposure.

If the exposure compensation is set to:	And if the exposure bracketing interval is set to 0.3 steps:	Then the exposures taken are:
0.0	(Set the Exposure Bracketing Interval in the Capture + menu.)	-0.3, 0.0, +0.3
+1.0		+0.7, +1.0, +1.3
-1.0		-1.3, -1.0, -0.7

## Using the histogram to view picture brightness

Use the histogram to evaluate the distribution of light before or after you take a picture. Optimal exposure is achieved when the peak is in the middle of the histogram. The flash may affect a picture's light and shadow.

To turn on the histogram in Capture mode or in Review, press the Info button until the histogram appears.

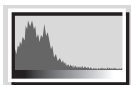

Dark picture



Balanced picture

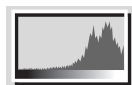

Bright picture

## Using the framing grid to compose a picture



The framing grid divides the LCD into thirds—vertically and horizontally. This is helpful if, for example, you want to balance a picture between water, earth, and sky. To turn on/off the framing grid, [see page 36](#).





## Sharing your pictures

Press the Share button to tag your pictures and videos. When they are transferred to your computer, you can share them. Use the Share button:

- Any time. (The most recent picture/video taken is then displayed.)
- After pressing the Review button.

## Tagging pictures for printing

- 1 Press the Share button. Press   to locate a picture.
- 2 Press   to highlight Print , then press OK.\*
- 3 Press   to select the number of copies (0-99).

**Optional:** You can apply a print quantity to other pictures with the print quantity screen displayed. Press   to locate a picture. Press   to change the print quantity. Repeat until the desired print quantity is applied to pictures.

- 4 Press OK.

*The Print icon  appears in the status area.*

- Press the Share button to exit the menu.

## Printing tagged pictures

When you transfer the tagged pictures to your computer, the Kodak EasyShare software print screen opens. For details, click the Help button in EasyShare software.

For more information on printing from your computer, printer dock, PictBridge enabled printer, or card, see [page 46](#).

NOTE: For the best 4 x 6 in. (10 x 15 cm) prints, set the camera to a 3:2 picture size.

## Tagging pictures/videos for email

### First—create email addresses

- 1 Press the Share button, then press ◀/▶ to find a picture/video.
- 2 Press ▲/▼ to highlight Email, then press OK.
- 3 Press ▲/▼ to highlight Add Email, then press OK.
- 4 Use the on-camera keyboard to create an email address and unique nickname. Highlight a letter, then press OK for each letter. When you're finished, highlight OK and press OK.

### Second—tag pictures/videos on your camera

- 1 Press ◀/▶ to find a picture/video, then press the Share button.
- 2 Press ▲/▼ to highlight Email, then press OK.
- 3 Press ▲/▼ to highlight an email address, then press OK.

To assign the same address to other pictures/videos, press ◀/▶ to scroll through pictures/videos. When the picture/video you want is displayed, press OK.

To send the pictures/videos to more than one address, repeat step 3.

*Selected addresses are checked.*

- 4 To remove a selection, highlight a checked address and press OK. To remove all email selections, highlight Clear All.
- 5 Press ▲/▼ to highlight Exit, then press OK.  
*The Email icon  appears in the status area.*
  - Press the Share button to exit the menu.

### Third—transfer and email

When you transfer these pictures/videos to your computer, EasyShare software prompts you to send them. For details, see Help in EasyShare software.



## Tagging pictures/videos with tags that you create

Use the Tag feature to create tag names and assign them to pictures/videos.

- 1 Press the Review button, then find a picture/video.
- 2 Press the Menu button.
- 3 Press  $\blacktriangle/\blacktriangledown$  to highlight Tag, then press OK.

NOTE: To add a tag name, use the Add Tag option, then use the on-camera keyboard.

- 4 Press  $\blacktriangle/\blacktriangledown$  to highlight a Tag name, then press OK.

To tag other pictures, press  $\blacktriangleleft/\blacktriangleright$  to scroll through pictures/videos. When the picture/video you want is displayed, press OK.

- 5 Press  $\blacktriangle/\blacktriangledown$  to highlight Exit, then press OK.

*The tag name appears with the picture. A plus (+) means the picture has more than one tag. When you transfer the tagged pictures/videos to your computer, EasyShare software opens and categorizes your pictures/videos with the appropriate tags.*

## Pre-tagging

Use the Set Tag feature to pre-select tag names before you take pictures/videos. Then, all the pictures/videos you take are tagged with those tag names. When Set Tag is in use, the tag appears while you are taking pictures/videos.

## Tagging pictures/videos as favorites

### Tag pictures as favorites

- 1 Press the Review button. Press  $\blacktriangleleft/\blacktriangleright$  to find a picture.
- 2 Press the Menu button, highlight Favorite, then press OK.

*The Favorite icon  appears in the status area. To remove the tag, press OK again.*

### View favorites on your camera

- 1 Press the Review button, then the Menu button.
- 2 Choose Search, then Favorites.

# 5

## Transferring and printing pictures

### Installing the software



#### CAUTION:

**Install EasyShare software *before* connecting the camera to the computer. Failure to do so may cause the software to load incorrectly.**

- 1 Close all software applications that are open on your computer (including anti-virus software).
- 2 Place the EasyShare software CD into the CD-ROM drive.
- 3 Load the software:

**Windows OS**—if the install window does not appear, choose Run from the Start menu and type **d:\setup.exe** where **d** is the drive letter that contains the CD.

**Mac OS X**—double-click the CD icon on the desktop, then click the Install icon.

- 4 Follow the on-screen instructions to install the software.

NOTE: When prompted, register your camera and software. To register later, see [www.kodak.com/go/register](http://www.kodak.com/go/register).

- 5 If prompted, restart the computer. If you turned off anti-virus software, turn it back on. See the anti-virus software manual for details.

For software help, click the Help button in EasyShare software.

## Transferring pictures with the USB cable

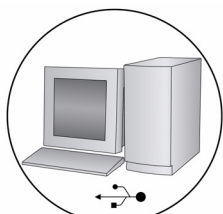

- 1 Turn off the camera.
- 2 Connect the USB cable (U-8).
- 3 Turn on the camera.

Kodak EasyShare software opens on your computer and prompts you through the transfer process.

NOTE: Visit [www.kodak.com/go/howto](http://www.kodak.com/go/howto) for an online tutorial on connecting.

### Also available for transferring

You can also use Kodak EasyShare docks to transfer your pictures and videos. Visit [www.kodak.com/go/z1015accessories](http://www.kodak.com/go/z1015accessories).

## Printing pictures

### Direct printing with an EasyShare all-in-one printer

Your camera is compatible with PictBridge technology, so you can print directly to PictBridge enabled printers. You need:

- Camera with fully charged battery
- PictBridge enabled printer
- USB cable (may be sold separately)

### Connecting the camera to an EasyShare all-in-one printer

- 1 Turn off the camera and printer.
- 2 Connect the appropriate USB cable from the camera to the printer. (See your printer user guide or visit [www.kodak.com/go/z1015accessories](http://www.kodak.com/go/z1015accessories).)

### Printing from an EasyShare all-in-one printer

- 1 Turn on the printer. Turn on the camera.

*The PictBridge logo is displayed, followed by the current picture and menu. (If no pictures are found, a message is displayed.) If the menu interface turns off, press any button to redisplay it.*

- 2 Press **▲/▼** to choose a printing option, then press OK.

**Current Picture**—Press **◀/▶** to choose a picture. Choose the number of copies.

**Print-Tagged Pictures**—If your printer is capable, print pictures that you tagged for printing and choose a print size.

**Index Print**—Print thumbnails of all pictures. This option requires one or more sheets of paper. If the printer is capable, choose a print size.

**All Pictures**—Print all pictures in internal memory or on a card. Choose the number of copies.

**Image Storage**—Access internal memory or card.

NOTE: During direct printing, pictures are not permanently transferred or saved to the computer or printer.

## Disconnecting the camera from an EasyShare all-in-one printer

- 1 Turn off the camera and printer.
- 2 Disconnect the USB cable from the camera and the printer.

## Using a printer that is not PictBridge enabled

For details on printing pictures from your computer, click Help in EasyShare software.

## Printing with a Kodak EasyShare printer dock

Dock your camera to the Kodak EasyShare printer dock and print directly—with or without a computer. Purchase this and other accessories at a dealer of Kodak products or visit [www.kodak.com/go/z1015accessories](http://www.kodak.com/go/z1015accessories).

To see which EasyShare printer docks are compatible with your camera, visit [www.kodak.com/go/dockcompatibility](http://www.kodak.com/go/dockcompatibility).

## Ordering prints online

Kodak Gallery ([www.kodakgallery.com](http://www.kodakgallery.com)) is one of the many online print services offered in the Kodak EasyShare software. You can easily:

- Upload your pictures.
- Edit, enhance, and add borders to your pictures.
- Store pictures, and share them with family and friends.
- Order high-quality prints, photo greeting cards, frames, and albums—and have them delivered to your door.

## Printing from an optional SD/SDHC card

- Automatically print print-tagged pictures when you insert your card into a printer with an SD/SDHC card slot. See your printer user guide for details.
- Make prints at an SD/SDHC card-capable Kodak picture maker/picture kiosk. (Contact a location prior to visiting. See [www.kodak.com/go/picturemaker](http://www.kodak.com/go/picturemaker).)
- Take the card to your local photo retailer for professional printing.

# 6

## Troubleshooting

**IMPORTANT:** *Your camera offers an on-board Help system. To get the most from your camera, see page 52.*

For step-by-step product support, visit [www.kodak.com/go/z1015support](http://www.kodak.com/go/z1015support) and select Interactive Troubleshooting & Repairs.

### Camera problems

If	Try one or more of the following
Camera does not turn on.	<ul style="list-style-type: none"><li>■ Install new battery (see page 1).</li><li>■ Charge rechargeable battery.</li></ul>
Camera does not turn off.	<ul style="list-style-type: none"><li>■ Remove the battery, then reinsert or replace it. If the camera still does not function, visit <a href="http://www.kodak.com/go/z1015support">www.kodak.com/go/z1015support</a> and select Interactive Troubleshooting &amp; Repairs.</li></ul>
Pictures remaining number does not decrease after taking a picture.	<ul style="list-style-type: none"><li>■ The camera is operating normally. Continue taking pictures.</li></ul>
Stored pictures are corrupted.	<ul style="list-style-type: none"><li>■ Retake pictures. Do not insert or remove a card when the camera is on. Keep rechargeable battery charged.</li><li>■ Transfer the pictures to the computer (see page 45), then format the card or internal memory (see page 37).</li></ul> <p><b>Caution: Formatting a card deletes all pictures and videos, including protected files.</b></p>
In Review mode, you do not see a picture (or the expected picture) on the LCD screen.	<ul style="list-style-type: none"><li>■ Check the image storage location setting (see page 35).</li></ul>

If	Try one or more of the following
In Review mode, a blue or black screen is displayed instead of a picture.	<ul style="list-style-type: none"> <li>■ Transfer the picture to the computer (<a href="#">see page 45</a>), then format the card or internal memory (<a href="#">see page 37</a>).</li> </ul> <p><b>Caution: Formatting a card deletes all pictures and videos, including protected files.</b></p>
Slide show does not run on external video device.	<ul style="list-style-type: none"> <li>■ Adjust the camera Video Out setting (NTSC or PAL, <a href="#">see page 37</a>).</li> <li>■ See the external device's user's guide.</li> </ul>
Picture is too light.	<ul style="list-style-type: none"> <li>■ Add more distance between the camera and the subject.</li> <li>■ Decrease Exposure Compensation (<a href="#">see page 38</a>).</li> </ul>
Picture is not clear.	<ul style="list-style-type: none"> <li>■ Clean the lens (<a href="#">see page 60</a>).</li> <li>■ Make sure your camera is not in Close-up mode.</li> <li>■ Press the shutter button halfway to focus and set exposure. When the framing marks turn green, press the Shutter button completely down.</li> <li>■ Place the camera on a flat, steady surface or use a tripod.</li> </ul>
Picture is too dark.	<ul style="list-style-type: none"> <li>■ Turn on the flash (<a href="#">see page 11</a>).</li> <li>■ Move within flash range (<a href="#">see page 11</a>).</li> <li>■ Use Fill flash (<a href="#">see page 11</a>) or change your position so light is not behind the subject.</li> <li>■ Increase Exposure Compensation (<a href="#">see page 38</a>).</li> </ul>
Camera does not recognize SD/SDHC card.	<ul style="list-style-type: none"> <li>■ Purchase a certified SD/SDHC card.</li> <li>■ Format the card (<a href="#">see page 37</a>).</li> </ul> <p><b>Caution: Formatting a card deletes all pictures and videos, including protected files.</b></p> <ul style="list-style-type: none"> <li>■ Insert a card into the slot, then push to seat (<a href="#">see page 5</a>).</li> </ul>
Camera freezes up when a card is inserted or removed.	<ul style="list-style-type: none"> <li>■ Turn the camera off, then back on. Make sure the camera is turned off before inserting or removing a card.</li> </ul>

If	Try one or more of the following
Memory card full.	<ul style="list-style-type: none"><li>■ Insert a new card (<a href="#">see page 5</a>), transfer pictures to the computer (<a href="#">see page 45</a>), or delete pictures (<a href="#">see page 18</a>).</li></ul>
Memory card and internal memory full.	<ul style="list-style-type: none"><li>■ Transfer pictures to the computer (<a href="#">see page 45</a>), then format the card or internal memory (<a href="#">see page 37</a>).</li></ul> <p><b>Caution: Formatting a card deletes all pictures and videos, including protected files.</b></p>

### Camera/computer communications

---

If	Try one or more of the following
The computer does not communicate with the camera.	<ul style="list-style-type: none"><li>■ Turn on the camera (<a href="#">see page 4</a>).</li><li>■ Install new battery (<a href="#">see page 1</a>) or charge rechargeable battery.</li><li>■ Connect cable to camera and computer port (<a href="#">see page 45</a>).</li><li>■ Install the software (<a href="#">see page 44</a>).</li><li>■ Disconnect the USB cable. Close all open applications. Re-install the software (<a href="#">see page 44</a>).</li><li>■ Disconnect camera from the computer. Close all software applications, reconnect camera.</li></ul>
Cannot transfer pictures. (The Add New Hardware Wizard cannot locate drivers.)	<ul style="list-style-type: none"><li>■ Disconnect USB cable. (If using camera dock or printer dock, disconnect cable and remove camera from dock). Close all open applications. Re-install the software (<a href="#">see page 44</a>).</li><li>■ Disconnect the USB cable. Close all open applications. Re-install the software (<a href="#">see page 44</a>).</li></ul>



## LCD messages

If	Try one or more of the following
No pictures or videos to display	<ul style="list-style-type: none"> <li>■ Change image storage location setting (see page 35).</li> </ul>
Memory card requires formatting	<ul style="list-style-type: none"> <li>■ Insert a new card (see page 5) or format the card (see page 37).</li> </ul>
Memory card cannot be read (Please format memory card or insert another card)	<p><b>Caution: Formatting a card deletes all pictures and videos, including protected files.</b></p>
Internal memory requires formatting	<ul style="list-style-type: none"> <li>■ Format the internal memory (see page 37).</li> </ul>
Internal memory cannot be read (Please format internal memory)	<p><b>Caution: Formatting deletes all pictures and videos, including protected files. (Formatting internal memory also deletes email addresses. To restore them, see the Kodak EasyShare software Help.)</b></p>
Memory card is unusable (Insert new memory card)	<ul style="list-style-type: none"> <li>■ Insert a new card (see page 5) or format the card (see page 37).</li> </ul> <p><b>Caution: Formatting a card deletes all pictures and videos, including protected files.</b></p>
High camera temperature. (Camera will be turned off.)	<ul style="list-style-type: none"> <li>■ Leave the camera off for ten minutes, then turn it back on. If the message reappears, visit <a href="http://www.kodak.com/go/z1015support">www.kodak.com/go/z1015support</a> and select Interactive Troubleshooting &amp; Repairs.</li> </ul>
Unrecognized file format	<ul style="list-style-type: none"> <li>■ Transfer the picture to the computer (see page 45), or delete it (page 18).</li> </ul>
Camera error #XXXX. See user's guide.	<ul style="list-style-type: none"> <li>■ Turn camera off, then back on. If the message reappears, visit <a href="http://www.kodak.com/go/z1015support">www.kodak.com/go/z1015support</a> and select Interactive Troubleshooting &amp; Repairs.</li> </ul>

# 7

## Getting help

### Getting help from your camera

You want the most from your camera. You want to understand:

- What it can do for you
- And how to take the best possible pictures and videos

### Great news!

Your camera offers a built-in Help system. It describes every setting for every menu choice. If you learn nothing else about your camera, learn how to use on-camera Help. Because the more you know your camera, the more confident you become!

### Turning on camera Help

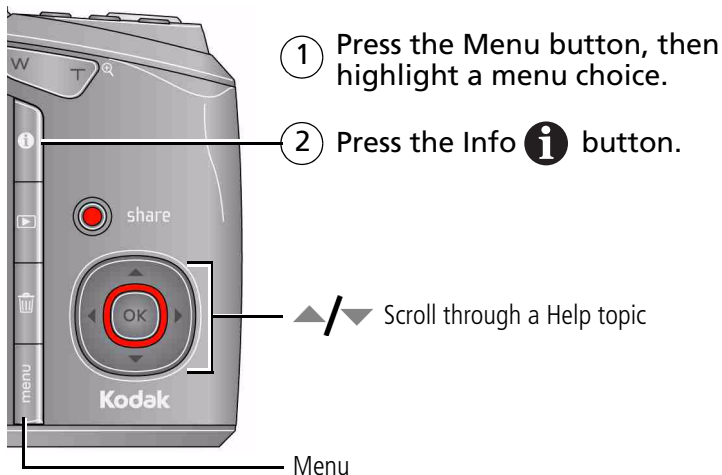

---

## Getting help on the Web

---

Email, write, or phone customer support	<a href="http://www.kodak.com/go/contact">www.kodak.com/go/contact</a>
Get support for your product (FAQs, arrange for repairs, troubleshooting information, etc.)	<a href="http://www.kodak.com/go/z1015support">www.kodak.com/go/z1015support</a>
Purchase camera accessories (camera docks, printer docks, lenses, cards, etc.)	<a href="http://www.kodak.com/go/z1015accessories">www.kodak.com/go/z1015accessories</a>
Download the latest camera firmware and software	<a href="http://www.kodak.com/go/z1015downloads">www.kodak.com/go/z1015downloads</a>
See online demonstrations of your camera	<a href="http://www.kodak.com/go/howto">www.kodak.com/go/howto</a>

---

## Software

---

Get information on EasyShare software	<a href="http://www.kodak.com/go/easysharesw">www.kodak.com/go/easysharesw</a> (or click the Help button in EasyShare software)
Get help with the Windows operating system and working with digital pictures	<a href="http://www.kodak.com/go/pcbasics">www.kodak.com/go/pcbasics</a>

---

## Other

---

Get support for other cameras, software, accessories	<a href="http://www.kodak.com/go/support">www.kodak.com/go/support</a>
Get information on Kodak EasyShare printer docks	<a href="http://www.kodak.com/go/printerdocks">www.kodak.com/go/printerdocks</a>
Get information on Kodak inkjet products	<a href="http://www.kodak.com/go/inkjet">www.kodak.com/go/inkjet</a>
Optimize your printer for truer, more vibrant colors	<a href="http://www.kodak.com/go/onetouch">www.kodak.com/go/onetouch</a>
Register your camera	<a href="http://www.kodak.com/go/register">www.kodak.com/go/register</a>

---

## Getting help on the telephone

NOTE: If you have questions concerning this product, you may speak with Kodak customer support.

Australia	1800 267 588	Netherlands	020 346 9372
Austria	0179 567 357	New Zealand	0800 880 120
Belgium	02 713 14 45	Norway	23 16 21 33
Brazil	0800 891 42 13	Philippines	1 800 1 888 9600
Canada	1 800 465 6325	Poland	00800 4411625
China	800 820 6027	Portugal	021 415 4125
Czech Republic	00 800 56325000	Russia	8 495 929 9166
Denmark	3 848 71 30	Singapore	800 6363 036
Finland	0800 1 17056	Slovakia	00 800 56325000
France	01 55 1740 77	Spain	91 749 76 53
Germany	069 5007 0035	Sweden	08 587 704 21
Greece	00800 44140775	Switzerland	044 838 53 51
Hong Kong	800 901 514	Taiwan	0800 096 868
Hungary	06 80 456 325	Thailand	001 800 631 0017
India	91 80 41374555 (toll free 000800 440 1227)	Turkey	00800 448827073
Ireland	01 407 3054	United Kingdom	0870 243 0270
Italy	02 696 33452	United States	1 800 235 6325
Japan	03 5540 9002	International Toll Line	+44 131 458 6714
Korea	080 708 5600	International Toll Fax	+44 131 458 6962

# 8

## Appendix

### Camera specifications

For more specifications, visit [www.kodak.com/go/z1015support](http://www.kodak.com/go/z1015support).

**CCD**—1/2.33-type

**Effective Pixels**—3648 x 2736 (10.0 MP)

**Lens**—15X optical zoom lens, 28–420 mm (35 mm equivalent); f/3.5–f/5.4

**Image stabilizer**—Sensor-shift type

**Digital zoom**—5.0X continuous

**Combined zoom**—75X

**Shutter speed**—1/30–1/1000 sec. in Smart Scene/Smart Capture; 16–1/1000 sec. in PASM

**Electronic viewfinder**—230 K dots; 100% field of view

**Color display**—7.6 cm (3.0 in) color hybrid LCD; 230 K dots; 30 fps

**External storage**—Optional SD/SDHC Card . (The SD logo is a trademark of the SD Card Association.)

**Internal storage**—64 MB (49 MB available for image storage. 1 MB equals one million bytes.)

**Focus system**—TTL-AF (through-the-lens auto focus); Multi-zone AF, Center-zone AF, and Selectable AF; working range in Smart Scene/Smart Capture mode:

0.7 m (2.3 ft)–infinity @ wide standard

2.5 m (8.2 ft)–infinity @ telephoto standard

0.1–1.0 m (0.3–3.3 ft) @ wide macro

0.7–3.5 m (2.3–11.5 ft) @ telephoto macro

**White balance**—Auto, Daylight, Tungsten, Fluorescent, Open Shade

**ISO speed**—Smart Scene/Smart Capture mode: Auto (80–1600)

PASM modes: Auto, 80, 100, 200, 400, 800, 1600, 3200, 6400 (ISO 3200 and 6400 available only in 3.1 MP and lower picture size.)

**Exposure metering**—TTL-AE; Multi-pattern, Center-weight, Spot

**Exposure compensation**—+/-2.0 EV with 1/3 EV steps

**Exposure bracketing**—3 images with selectable +/- 0.3 EV steps

**Electronic flash**—Auto flash; Guide no. 9; working range in Smart Scene/Smart Capture mode (ISO 400): 5.0 m (16.4 ft) @ wide; 3.2 m (10.5 ft) @ telephoto

**Flash compensation**—+/-1.0 in 1/3 steps

**Flash modes**—Auto, Fill, Red-eye, Off

**Capture modes**—Smart Scene/Smart Capture, High ISO, Sport, Program, Aperture, Shutter, Manual, Panorama, SCN modes, Video

**Drive modes**—Single shot, first burst, last burst, self-timer (10-second, 2-shot, and 2-second)

**File format**—Still: JPEG/EXIF 2.21, RAW; Video: QuickTime, MPEG-4

**Color modes**—High Color, Natural Color, Low Color, Black & White, Sepia

**Sharpness**—High, Normal, Low

**Video size**—1280 x 720 @ 30 fps (HDV); 640 x 480 @ 30 fps (VGA); 320 x 240 @ 30 fps (QVGA)

**Video length**—HDV: < 30 mins. VGA/QVGA: < 80 mins.

**Video output**—NTSC or PAL selectable

**Power**—1 Kodak Li-Ion rechargeable digital camera battery KLIC-8000; 1 Kodak lithium digital camera battery CRV3 (non-rechargeable); 5V AC adapter; Kodak EasyShare docks

**Burst mode**—Maximum 3 pictures @ 2.1 fps in Smart Scene/Smart Capture mode; Auto Exposure, Auto Focus, Auto White Balance executed for first shot only

**Self-timer**—2 seconds, 10 seconds, or 2-shot

**Output image size**—

**Smart Scene/Smart Capture Mode**

10.0 MP (4:3): 3648 x 2736 pixels

8.9 MP (3:2): 3648 x 2432 pixels

7.5 MP (16:9): 3648 x 2064 pixels

5.0 MP (4:3): 2592 x 1944 pixels

4.5 MP (3:2): 2592 x 1728 pixels

3.8 MP (16:9): 2592 x 1456 pixels

3.1 MP (4:3): 2048 x 1536 pixels

2.8 MP (3:2): 2048 x 1360 pixels

2.4 MP (16:9): 2048 x 1152 pixels

**Other Modes**

10.0 MP (4:3): 3648 x 2736 pixels

8.9 MP (3:2): 3648 x 2432 pixels

7.5 MP (16:9): 3648 x 2064 pixels

5.0 MP (4:3): 2592 x 1944 pixels

3.1 MP (4:3): 2048 x 1536 pixels

2.2 MP (3:2): 1800 x 1200 pixels

2.1 MP (16:9): 1920 x 1080 pixels

1.2 MP (4:3): 1280 x 960 pixels

**Compression**—Fine, Basic, Standard, RAW

**Communication with computer**—USB 2.0 high speed (PIMA 15740 protocol) via USB cable model U-8; USB 2.0 full speed (PIMA 15740 protocol) via compatible EasyShare dock

**PictBridge compatibility**—Yes

**Auto power off**—Selectable 1, 3, 5, 10 minutes

**Microphone**—Yes

**Speaker**—Yes

**Sound tag**—Yes

**Date stamp**—Yes

**Tripod mount**—1/4 inch

**Size**—108.5 x 74.2 x 76.6 mm (4.3 x 2.9 x 3.0 in.) @ power off

**Weight**—325 g (11.5 oz) without battery or card

**Operating temperature**—32-104°F (0-40°C)

## Storage capacities

The LCD displays the number of pictures (or minutes/seconds of video) remaining. For average SD card capacities, visit [www.kodak.com/go/SDcapacities](http://www.kodak.com/go/SDcapacities). Actual storage capacity varies depending on subject composition, card size, and other factors. You may be able to store more or fewer pictures and videos.

## Upgrading your software and firmware

Download the latest versions of the software included on the Kodak EasyShare software CD and the camera firmware (the software that runs on the camera). See [www.kodak.com/go/z1015downloads](http://www.kodak.com/go/z1015downloads).

## Important safety instructions



### CAUTION:

**Do not disassemble this product; there are no user-serviceable parts inside. Refer servicing to qualified service personnel. Kodak AC adapters and battery chargers are intended for indoor use only. The use of controls, adjustments, or procedures other than those specified herein may result in exposure to shock and/or electrical or mechanical hazards. If the LCD breaks, do not touch the glass or liquid. Contact Kodak customer support.**

- The use of an accessory that is not recommended by Kodak may cause fire, electric shock, or injury. For approved accessories, visit [www.kodak.com/go/accessories](http://www.kodak.com/go/accessories).
- Use only a USB-certified computer equipped with a current-limiting motherboard. Contact your computer manufacturer if you have questions.
- If using this product in an airplane, observe all instructions of the airline.
- When removing the battery, allow it to cool; it may be hot.
- Follow all warnings and instructions supplied by the battery manufacturer.



- Use only batteries approved for this product to avoid risk of explosion.
- Keep batteries out of the reach of children.
- Do not allow batteries to touch metal objects, including coins. Otherwise, a battery may short circuit, discharge energy, become hot, or leak.
- Do not disassemble, install backward, or expose batteries to liquid, moisture, fire, or extreme temperature.
- Remove the battery when the product is stored for an extended period of time. In the unlikely event that battery fluid leaks inside the product, contact Kodak customer support.
- In the unlikely event that battery fluid leaks onto your skin, wash immediately with water and contact your local health provider. For additional health-related information, contact your local Kodak customer support.
- Dispose of batteries according to regulations. Visit [www.kodak.com/go/kes](http://www.kodak.com/go/kes).
- Do not charge non-rechargeable batteries.

For more information on batteries, see [www.kodak.com/go/batterytupes](http://www.kodak.com/go/batterytupes).

## Battery life

- CRV3 lithium digital camera battery: 300 pictures
  - KLIC-8000 Li-ion rechargeable digital camera battery (per charge): 270 pictures
- Battery life per CIPA testing method using 128 MB SD card. Approximate number of pictures in Smart Scene/Smart Capture mode. Actual life may vary based on usage.

## Extending battery life

- Use power-saving features.
- Limit activities that quickly deplete battery power (reviewing pictures on the camera, excessive use of the flash).
- Dirt on the battery contacts can affect battery life. Wipe the contacts with a clean, dry cloth before loading a battery in the camera.

- Battery performance is reduced at temperatures below 41° F (5° C). When using your camera in cold weather, carry spare batteries and keep them warm. Do not discard cold batteries that do not work; when they return to room temperature, they may be usable.

## Care and maintenance

- If you suspect water has gotten inside the camera, remove the battery and card. Allow all components to air-dry for at least 24 hours before using the camera.
- Blow gently on the lens or LCD to remove dust and dirt. Wipe gently with a soft, lint-free cloth or an untreated lens-cleaning tissue. Do not use cleaning solutions unless designed specifically for camera lenses. Do not allow chemicals, such as suntan lotion, to contact painted surfaces.
- Service agreements may be available in your country. Contact a dealer of Kodak products for more information.
- For digital camera disposal or recycling information, contact your local authorities. In the US, visit the Electronics Industry Alliance Web site at [www.eiae.org](http://www.eiae.org) or the Kodak Web site at [www.kodak.com/go/z1015support](http://www.kodak.com/go/z1015support).

## Limited warranty

Kodak warrants Kodak consumer electronic products and accessories (“Products”), excluding batteries, to be free from malfunctions and defects in both materials and workmanship for one year from the date of purchase. Retain the original dated sales receipt. Proof of the date of purchase is required with any request for warranty repair.

### Limited warranty coverage

Warranty service is only available from within the country where the Products were originally purchased. You may be required to ship Products, at your expense, to the authorized service facility for the country where the Products were purchased. Kodak will repair or replace Products if they fail to function properly during the warranty period, subject to any conditions and/or limitations stated herein. Warranty service will include all labor as well as any necessary adjustments and/or replacement parts.

If Kodak is unable to repair or replace a Product, Kodak will, at its option, refund the purchase price paid for the Product provided the Product has been returned to Kodak along with proof of the purchase price paid. Repair, replacement, or refund of the purchase price are the sole remedies under the warranty. If replacement parts are used in making repairs, those parts may be remanufactured, or may contain remanufactured materials. If it is necessary to replace the entire Product, it may be replaced with a remanufactured Product. Remanufactured Products, parts and materials are warranted for the remaining warranty term of the original Product, or 90 days after the date of repair or replacement, whichever is longer.

### **Limitations**

This warranty does not cover circumstances beyond Kodak's control. This warranty does not apply when failure is due to shipping damage, accident, alteration, modification, unauthorized service, misuse, abuse, use with incompatible accessories or attachments (such as third party ink or ink tanks), failure to follow Kodak's operation, maintenance or repacking instructions, failure to use items supplied by Kodak (such as adapters and cables), or claims made after the duration of this warranty.

Kodak makes no other express or implied warranty for this product, and disclaims the implied warranties of merchantability and fitness for a particular purpose. In the event that the exclusion of any implied warranty is ineffective under the law, the duration of the implied warranty will be one year from the purchase date or such longer period as required by law. The option of repair, replacement, or refund is Kodak's only obligation. Kodak will not be responsible for any special, consequential or incidental damages resulting from the sale, purchase, or use of this product regardless of the cause. Liability for any special, consequential or incidental damages (including but not limited to loss of revenue or profit, downtime costs, loss of the use of the equipment, cost of substitute equipment, facilities or services, or claims of your customers for such damages resulting from the purchase use or failure of the Product), regardless of cause or for breach of any written or implied warranty is expressly disclaimed.

## Your rights

Some states or jurisdictions do not allow exclusion or limitation of incidental or consequential damages, so the above limitation or exclusion may not apply to you. Some states or jurisdictions do not allow limitations on how long an implied warranty lasts, so the above limitation may not apply to you. This warranty gives you specific rights, and you may have other rights which vary from state to state or by jurisdiction.

## Outside the United States and Canada

In countries other than the United States and Canada, the terms and conditions of this warranty may be different. Unless a specific Kodak warranty is communicated to the purchaser in writing by a Kodak company, no warranty or liability exists beyond any minimum requirements imposed by law, even though defect, damage, or loss may be by negligence or other act.

# Regulatory compliance

## FCC compliance and advisory

**FC** Kodak EasyShare Z1015 IS digital camera

This equipment has been tested and found to comply with the limits for a Class B digital device, pursuant to Part 15 of the FCC Rules. These limits are designed to provide reasonable protection against harmful interference in a residential installation. This equipment generates, uses, and can radiate radio frequency energy and, if not installed or used in accordance with the instructions, may cause harmful interference to radio communications. However, there is no guarantee that interference will not occur in a particular installation. If this equipment does cause harmful interference to radio or television reception, which can be determined by turning the equipment off and on, the user is encouraged to try to correct the interference by one or more of the following measures: 1) reorient or relocate the receiving antenna; 2) increase the separation between the equipment and the receiver; 3) connect the equipment to an outlet on a circuit different from that to which the receiver is connected; 4) consult the dealer or an experienced radio/TV

technician for additional suggestions. Any changes or modifications not expressly approved by the party responsible for compliance could void the user's authority to operate the equipment. Where shielded interface cables have been provided with the product or specified additional components or accessories elsewhere defined to be used with the installation of the product, they must be used in order to ensure compliance with FCC regulation.

## Australian C-Tick



## Canadian DOC statement

**DOC Class B Compliance**—This Class B digital apparatus complies with Canadian ICES-003.

**Observation des normes-Classe B**—Cet appareil numérique de la classe B est conforme à la norme NMB-003 du Canada.

## FCC and Industry Canada

This device complies with Industry Canada RSS-210 and FCC Rules. Operation is subject to the following two conditions: (1) this device may not cause harmful interference, and (2) this device must accept any interference received, including interference that may cause undesired operation.

FCC et Industrie Canada

Cet appareil est conforme à la norme RSS-210 d'Industrie Canada et aux réglementations de la FCC. Son utilisation est soumise aux deux conditions suivantes : (1) cet appareil ne doit pas provoquer d'interférences nuisibles, et (2) cet appareil doit supporter les interférences reçues, y compris celles susceptibles de nuire à son bon fonctionnement.

## Waste Electrical and Electronic Equipment labeling



EU: It is the final user's responsibility to discard this equipment into an approved, segregated collection scheme to enable its suitable treatment/disposal and to improve human/environmental protection. For more information, see your retailer, local authority, or [www.kodak.com/go/recycle](http://www.kodak.com/go/recycle). (Product weight: 325 g.)

## Korean Class B ITE

이 기기는 가정용으로 전자파적합등록을 한 기기로서 주거지역에서는 물론 모든 지역에서 사용할 수 있습니다.

## VCCI Class B ITE

この装置は、情報処理装置等電波障害自主規制協議会（VCCI）の基準に基づいたクラスB情報技術装置です。この装置は、家庭環境で使用することを目的としていますが、この装置がラジオやテレビジョン受信機に近接して使用されると、受信障害を引き起こすことがあります。  
取扱説明書に従って正しい取り扱いをして下さい。

## China RoHS

### 环保使用期限 (EPUP)

在中国大陆, 该值表示产品中存在的任何危险物质不得释放, 以免危及人身健康、财产或环境的时间期限 (以年计)。该值根据操作说明中所规定的产品正常使用而定。

### 有毒有害物质或元素名称及含量标识表

部件名称	有毒有害物质或元素					
	铅	汞	镉	六价铬	多溴联苯	多溴二苯醚
数码相机电路板元件	×	○	○	○	○	○
锂电池	×	○	○	○	○	○
交流变压器	×	○	○	○	○	○

○：表示该有毒有害物质在该部件所有均质材料中的含量均在SJ/T 11363-2006规定的限量要求以下。  
×：表示该有毒有害物质至少在该部件的某一均质材料中的含量超出SJ/T 11363-2006规定的限量要求。



USB 数据线

## Russian GOST-R



Eastman Kodak Company  
Rochester, NY 14650

А10-40 Фотокамера изготовлена в Китае; остальные элементы -  
в соответствии с маркировкой.

## MPEG-4

Use of this product in any manner that complies with the MPEG-4 visual standard is prohibited, except for use by a consumer engaging in personal and non-commercial activities.

---

# Index

## A

- A/V out, 27
- about picture, video, 18
- about this camera, 37
- accessories, 45
  - battery, 59
  - buying, 53
  - printer dock, 47
  - SD/SDHC card, 5
- advanced digital zoom, 36
- AF control, 33
- aperture priority, 38
- appendix, 55
- auto
  - enhancement, 22
  - flash, 11
  - focus framing marks, 7

## B

- backlight, 9
- battery
  - charging, 3
  - life, 59
  - loading, 1
- beach, 9
- bookmarks, 24
- burst, using, 14
- button
  - burst, 14
  - EVF/LCD, ii
  - flash, 11
  - info, ii

- review, 17
- share, ii
- zoom, ii, 10

## C

- cable
  - audio/video, 27
  - USB, 45
- camera sounds, 36
- candle light, 9
- capture frame grid, 36
- caring for your camera, 60
- charging the battery, 3
- clock, setting, 4
- color mode, 33
- compatibility, dock, 47
- compression, 32
- continuous AF, 33
- copy pictures
  - card to memory, 29
  - memory to card, 29
  - to computer, 44
- cropping pictures, 21
- customer support, 53, 54

## D

- date setting, 4
- date stamp, 36
- DC-in, i
- deleting
  - pictures/video, 18
  - protecting pictures, videos, 19



digital zoom, using, 10  
displaying slide show, 25  
disposal, recycling, 60, 64  
dock  
    connector, ii  
dock compatibility, 47  
doing more with your camera, 31  
download pictures, 44

## E

EasyShare software, installing, 44  
emailing pictures, videos, 42  
error messages, 51  
EVF (electronic viewfinder), ii  
EVF/LCD button, ii  
exposure  
    bracketing interval, 35  
    compensation, 38  
    metering, 34  
external video device  
    viewing pictures, videos, 27

## F

favorites  
    tagging, 43  
filter pictures, videos, 28  
fireworks, 9  
firmware, upgrading, 58  
flash  
    settings, 11  
flower, 9  
focus  
    framing marks, 7  
    zone, 34

focus mode  
    infinity, 12  
    macro, 12  
format, card or internal memory, 37  
framing grid, 40

## G

grid, framing, 40  
guidelines, battery, 59

## H

HDTV  
    format, 32  
help, 48  
    camera help, 52  
    web links, 53  
high ISO, 8  
histogram, 40

## I

icons  
    mode dial, 8  
    picture-taking, 16  
    review, 30  
image stabilizer, 36  
image storage, 35  
info button, ii  
information  
    about pictures, videos, 18  
installing  
    battery, 1  
    SD/SDHC card, 5  
    software, 44  
internal memory, storage capacity, 58

## K

- Kodak EasyShare software
  - installing, 44
  - upgrading, 58
- Kodak Perfect Touch technology, 22
- Kodak web sites, 53

## L

- landscape, 9
- LCD, ii
  - brightness, 35
  - reviewing pictures, 17
  - reviewing videos, 17
- lens, cleaning, 60
- loading
  - battery, 1
  - SD/SDHC card, 5
  - software, 44

## M

- Macintosh computers, installing
  - software on, 44
- magnify picture, 17
- maintenance, camera, 60
- make picture from video, 23
- manner/museum, 9
- manual, 38
- memory
  - inserting card, 5
  - storage capacity, 58
- mode dial, 8
- modes
  - aperture priority, 38
  - manual, 38

- shutter priority, 38
- modes, capture
  - high ISO, 8
  - SCN (scene), 8
  - smart scene/smart capture, 8
  - video, 8
- multimedia slide show, 26
- multiple picture selections, 29
- multi-up, 28

## N

- night landscape, 9
- night portrait, 9

## O

- online prints, ordering, 47
- optical zoom, 10
- orientation sensor, 36

## P

- panoramic pictures, 15
- PASM mode, 38
- Perfect Touch technology, 22
- PictBridge enabled printer, 46
- picture size, 32
- picture/video settings, 31
- pictures
  - checking settings, 30
  - copying, 29
  - cropping, 21
  - deleting, 18
  - emailing tagged, 42
  - from video, 23
  - Kodak Perfect Touch, 22
  - magnifying, 17

- printing, 47
- protecting, 19
- reviewing, 17
- storage capacity, 58
- taking, modes, 8
- transfer, 44

portrait, 9

power, camera, 4

printer dock, 47

printing

- from a card, 47
- from computer, 47
- optimizing printer, 53
- order online, 47
- PictBridge technology, 46
- tagged pictures, 47
- with EasyShare printer dock, 47

problem-solving, 48

protecting pictures, videos, 19

## Q

quickview

- setting, 36

## R

RAW file format, 22

recycling, disposal, 60, 64

red-eye, flash, 11

regulatory information, 62

repair, 53

reset camera, 37

review button, 17

reviewing pictures/videos

- after taking, 17

- deleting, 18
- protecting, 19
- slide show, 25

running a slide show, 25

## S

scene modes, 9

- backlight, 9
- beach, 9
- candle light, 9
- fireworks, 9
- flower, 9
- landscape, 9
- manner/museum, 9
- night landscape, 9
- night portrait, 9
- panorama, 15
- portrait, 9
- self-portrait, 9
- snow, 9
- stage, 9
- sunset, 9
- text, 9

SCN (scene), 8

SD card

- slot, ii

SD/SDHC card

- inserting, 5
- printing from, 47
- storage capacities, 58

search pictures, videos, 28

select multiple pictures/videos, 29

self-portrait, 9

self-timer

- with pictures, 13
- service and support telephone numbers, 54
- setting
  - about this camera, 37
  - advanced digital zoom, 36
  - AF control, 33
  - camera sounds, 36
  - capture frame grid, 36
  - color mode, 33
  - date and time, 4
  - date stamp, 36
  - exposure bracketing, 35
  - exposure metering, 34
  - flash, 11
  - focus zone, 34
  - image stabilizer, 36
  - image storage, 35
  - LCD brightness, 35
  - orientation sensor, 36
  - picture size, 32
  - picture taking modes, 8
  - picture/video, 31
  - quickview, 36
  - reset camera, 37
  - self-timer, 13
  - sharpness, 35
  - sound volume, 37
  - tag, 35
  - video out, 37
  - video size, 32
  - white balance, 33, 34
- share button, ii
- sharing pictures, videos, 41

- sharpness, 35
- shutter
  - priority, 38
  - self-timer delay, 13
  - speed, 38
- single AF, 33
- slide show
  - continuous loop, 26
  - problems, 49
  - running, 25
- smart scene/smart capture, 8
- snow, 9
- software
  - installing, 44
  - upgrading, 58
- sort pictures, videos, 28
- sound volume, 37
- sounds, camera, 36
- specifications, camera, 55
- stage, 9
- storage capacity, 58
- strap, 1
- sunset, 9
- support, technical, 53, 54

## T

- tag
  - favorites, 43
  - for email, 42
  - for print, 41
  - set, 35
- telephone support, 54
- television, slide show, 27
- text, 9

time, setting, 4  
timer, shutter delay, 13  
transferring pictures, videos, 44  
tripod socket, ii  
troubleshooting, 48  
    camera, 48  
    camera/computer  
        communications, 50  
        error messages, 51  
turning camera on/off, 4

## U

undelete, 19  
upgrading software, firmware, 58  
URLs, Kodak web sites, 53  
USB cable, 45

## V

video, 8  
    action print, 25  
    bookmarks, 24  
    checking settings, 30  
    copying, 29  
    emailing tagged, 42  
    out, 37  
    protecting, 19  
optical, 10

    reviewing, 17  
    size, 32  
    storage capacities, 58  
    transfer, 44  
    viewing, 17  
viewfinder, ii  
viewing  
    by date, tag, 28  
    by multi-up, 28  
viewing picture/video  
    after taking, 17  
    information, 18  
volume, adjusting, 37

## W

warranty, 60  
WEEE, 64  
white balance, 33, 34  
Windows OS-based computers  
    installing software, 44

## Z

zoom  
    button, ii  
    digital, 10  
    optical, 10