KODAK EASYSHARE W820/W1020 Wireless Digital Frames



Extended user guide

www.kodak.com

For help with your digital frame, www.kodak.com/go/digitalframesupport

Kodak

Eastman Kodak Company

Rochester, New York 14650

© Eastman Kodak Company, 2008

All screen images are simulated.

Kodak and EasyShare are trademarks of Eastman Kodak Company.

Eastman Kodak Company is an authorized licensee of the CompactFlash trademark.

P/N 4H5172_en

Front View

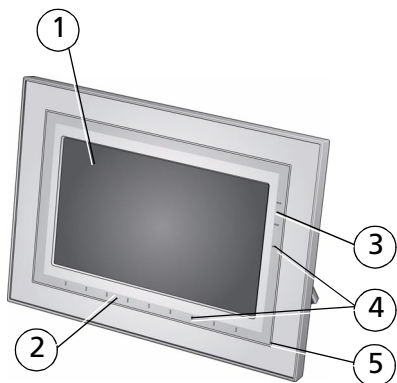



- 1 LCD screen
- 2 Touch border (tap/slide)
- 3 Touch border (tap only)
- 4 Lights
- 5 Raised guide

NOTE: When screen icons appear, lights turn on at touch-sensitive points near the raised guide.

To use the touch border,
see page 3.

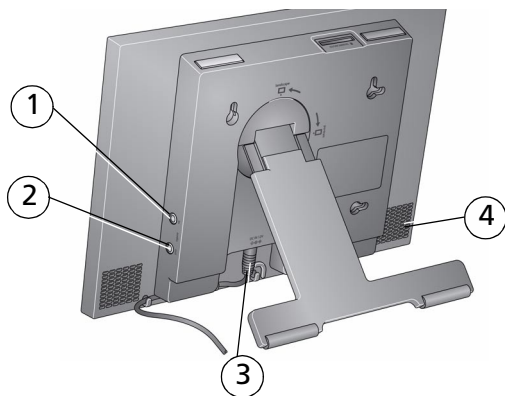
Back/Right View



- 1 Audio In
- 2 Audio Out 
- 3 DC-In (12V) 
- 4 Speakers (2)

Back/Side View

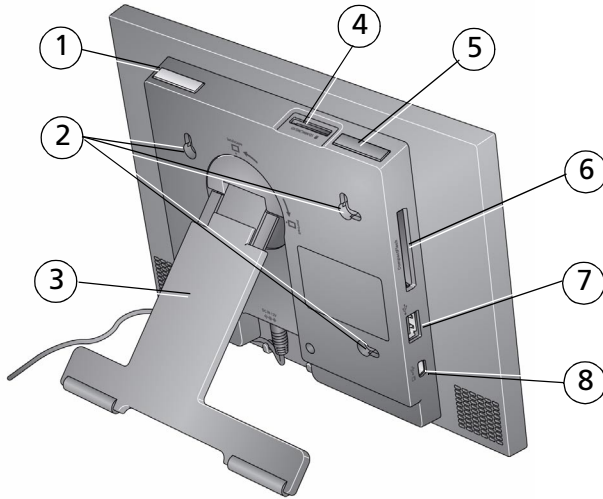

- | | | | |
|---|---|---|--------------------------------------|
| 1 | Power button | 5 | Volume button |
| 2 | Wall mounting holes | 6 | Memory card slot - CF, MD |
| 3 | Rotating/extendable stand (see page 1) | 7 | USB connector (to camera/USB device) |
| 4 | Memory card slot - SD/SDHC, MMC, MS, xD | 8 | USB connector (to computer) |

Table of contents

1 Getting started	1
Setting up your frame.....	1
Turning on/off your frame.....	2
Using your frame's Quick Touch Borders.....	3
Setting your language	4
Connecting to your wireless network.....	4
2 Setting up for wireless operation	5
Connecting to your wireless network.....	5
Installing the software: WINDOWS OS only.....	9
Verifying computer/device connections	10
3 Setting up Web content	12
Setting up access to the Gallery and Web media.....	12
Connecting to your Gallery account	16
Connecting to your FLICKR account.....	17
Connecting to your FRAMECHANNEL account	18
Adding Web feeds.....	19
Creating shortcuts on your frame.....	25
Previewing, editing, and deleting feeds.....	26
4 Viewing on your frame	28
Enjoying your pictures immediately!	28
Inserting a memory card.....	28
Connecting a digital camera or other USB device	29
Viewing the Home screen.....	30
Accessing your pictures and videos.....	32
Viewing pictures and videos	33
Playing a slide show.....	35
Arranging pictures to play by date or filename	36
5 Doing more with your frame	37

Playing music.....	37
Playing a video.....	38
Printing pictures.....	39
Copying on your frame.....	41
Deleting pictures.....	42
Selecting multiple pictures.....	43
6 Using wireless mode.....	44
What are the wireless features of my frame?.....	44
Setting up your frame for wireless operation.....	44
Wireless networking and the Internet.....	44
Viewing pictures/videos wirelessly.....	45
Viewing Gallery/Web media content on your frame.....	46
Automatically receiving My Friends Albums.....	49
Emailing pictures and videos from your frame.....	51
Copying wirelessly to/from your computer.....	53
7 Changing settings and more.....	57
Changing frame settings.....	57
Settings menus.....	57
Setting the clock and timer.....	60
Upgrading your software and firmware.....	62
Adding a matte and faceplate.....	64
Mounting your frame on the wall.....	64
Changing your frame orientation.....	65
Maintaining your frame and mattes.....	66
Learning more about your frame.....	66
8 Troubleshooting and support.....	67
Frequently asked questions.....	67
Picture frame problems.....	68
Picture frame/computer communications.....	70
Screen messages.....	71

9 Appendix	73
Digital frame specifications.....	73
Important safety instructions	75
Additional care and maintenance	76
Limited warranty	76
Regulatory compliance	78

1

Getting started

Welcome to your KODAK EASYSHARE W820/W1020 Wireless Digital Frame. Viewing your pictures couldn't be simpler!

Setting up your frame

Setting up the stand

Your frame displays pictures in landscape  orientation. To change to portrait  orientation, see [page 65](#).

Stand (pull to adjust the frame angle for best viewing)

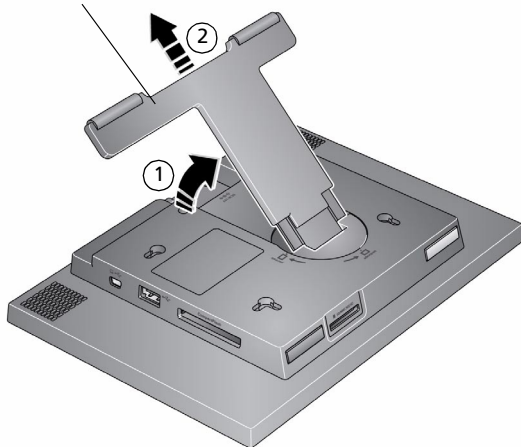

When displayed with the stand extended, the frame rests at a 68-90 ° angle.

Attaching the power cable



CAUTION:

Do not use this power cable with other devices, including digital cameras.

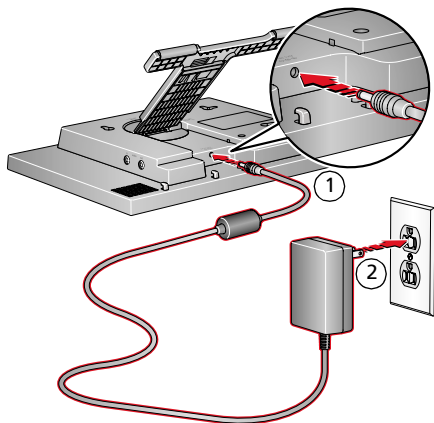

Your power cable may look different from the one pictured. Use the plug that accommodates your type of power outlet.

Turning on/off your frame

Power button - press and hold (for about 2 seconds), then release.

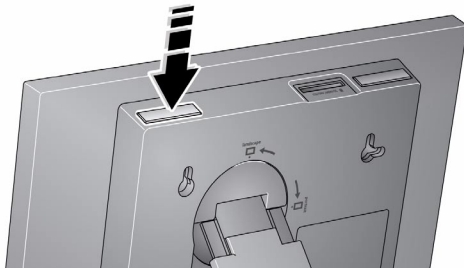

With the power cable still plugged in, your frame retains information (like the time) if you turn it off.

Using your frame's Quick Touch Borders

IMPORTANT: *The display screen is not touch-sensitive. Do not touch it. Lights appear on the borders (upper right and bottom) to show you where to touch.*



CAUTION:

Only use your finger to touch the borders. Using sharp or metal objects may damage the border or screen.

Touch tips

Tap and slide on the Quick Touch Borders* only.

- **Tap** a border to display the icons. Tap Close to dismiss them.
- **Tap** the light closest to an icon* to select it.
- **Slide** to highlight menus, pictures, videos, options.** Tap OK to select them.
- **Don't hover**, borders can be sensitive.

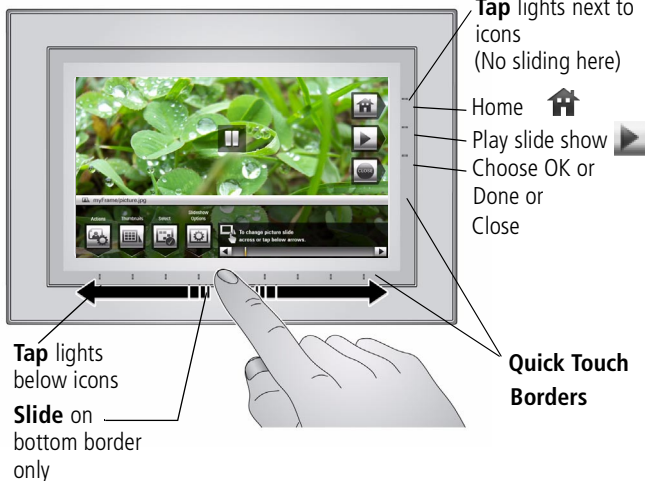

Slide to scroll:

- Scroll through images—Like turning the pages of a book, slide left ← to go forward, slide right → to go back. For faster scrolling through larger numbers of pictures, touch and hold (3 seconds), then slide to the end of the border.
- Scroll through menus—Slide right → to scroll down, slide left ← to scroll up.

* Icons change color when they are selected.

** **Tap below small arrows at the ends of the scroll bar** to move the highlight one picture, menu, or item at a time.

Setting your language

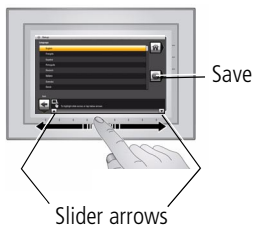

The language screen appears the first time you turn on your frame.



- Slide (or tap below slider arrows) on the lights at the bottom border to highlight your language, then tap Save.

NOTE: Slide left/right on the lights to move up or down the list.

To change the language at a later time:

- Tap  (Home) →  (Settings) → Language.
The language screen appears.

Slide to highlight your language, then tap Save.

To use the Quick Touch Borders, see [page 3](#).

Connecting to your wireless network

After you set your language, your frame scans for available wireless networks. See [Connecting to your wireless network, page 5](#).

2

Setting up for wireless operation

If you have problems with your wireless setup or connection, see Troubleshooting starting on [page 67](#). Or open EASYSHARE Digital Display Software on your computer (see [page 9](#)) and click Tools → Wireless Troubleshooter. Follow the automated troubleshooting wizard.

Connecting to your wireless network

To allow your frame to access the contents of your computer wirelessly, connect your frame to your wireless home network.

NOTE: If you are not sure you have a wireless network, ask the person who set up your computer.

- 1 First time**—If this is the first time you turned on your frame, tap the light next to Save after you set your language (see [page 4](#)).

The Scanning for available wireless networks screen appears.

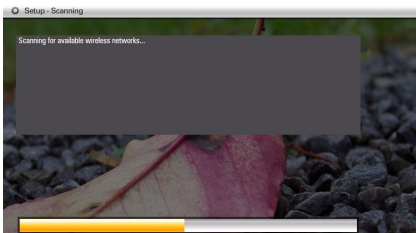

Available wireless networks are listed.

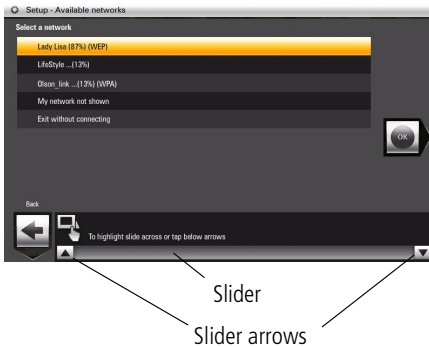

NOTE:



If the scan finds multiple networks, your home network (with the highest % signal strength) is usually listed first and highlighted. Tap OK.

Or, to select another network, slide or tap below the arrows to highlight a network, then tap OK.

You can slide to highlight Exit without connecting, then tap OK (or tap Back) to dismiss the screen and go to the Home screen (see [page 30](#)).

If you want to connect to your wireless home network later and start enjoying your pictures now, insert a memory card. Or, connect a camera or other USB device with pictures (see [page 29](#)).

Later—To connect to your wireless home network later:

- a. Tap Home  → Settings .
- b. Slide to highlight Network, then tap Select.
- c. Highlight Scan for wireless networks, then tap OK.
- d. Follow the screen prompts and continue with step 2 below.

If your wireless network is not found:

- a. Slide to highlight My network not shown, then select OK.
- b. Check that your router is on and your frame is close to the router, then select Scan again.

If your wireless network is still not found, your network does not broadcast SSIDs. You then need to enter your network SSID (sometimes called the network name) manually:

- a. Select Enter SSID, then tap OK.

The on-screen keyboard appears.

- b. Using the on-screen keyboard, enter the SSID in the text box, ([see page 7](#)). Tap Done when finished.

The person who set up your network can help you with this information. Or, tap Back then tap Help me connect for more information.

- 2 With your home network highlighted, tap OK to connect to your home network.
The Connecting (or the wireless network security screen, if enabled) appears.

Or, tap Exit to go to the Home screen without connecting. (See [page 30](#).)

Enter security key (if you have wireless network security enabled)

You are prompted to enter your security key (WEP or WPA) using the on-screen keyboard. Slide along the bottom of the touch border (or tap below the slider arrows) to highlight a character, then tap  (Select) to enter it in the text box. Tap Done when you are finished entering all the characters.

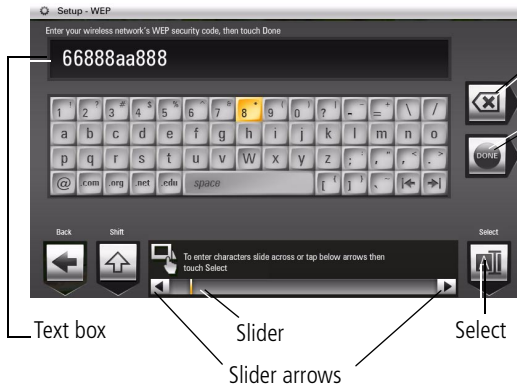

Backspace - erases text

Done

Touch tips

- Right border - tap only
- On the bottom border, keep sliding (or tapping slider arrows) left/right to go to the previous or next row.

If you do not have security enabled, go to step 3. (We recommend that you enable your network security to prevent others from accessing your wireless home network.)

NOTE: The screen identifies your security as either **WEP** or **WPA**.

A **WEP** security key can be either:

5 or 13 characters (0-9, A-Z, some special characters, case sensitive)

10 or 26 characters (0-9, A-F, not case sensitive).

A **WPA** key is 8-63 characters, case sensitive.

The person who set up your network can provide you with this information.



Congratulations! You have successfully connected your frame to your wireless network!

- 3 If you haven't done so already, install the KODAK EASYSHARE Digital Display Software on your WINDOWS OS computer (see [page 9](#)) so you can set up and customize your frame right from your computer wirelessly. For MAC OS users, see [page 15](#).
- 4 Tap OK when you are done installing the software.

Installing the software: WINDOWS OS only

IMPORTANT: For MAC OS users, do not install the software on your computer. See [page 15](#) to open your frame's Device Settings page in your browser to start setting access to Web content and customizing your frame.

The CD that was packaged with your frame contains two applications that work well independently, but also work together for the best experience with your frame:

- KODAK EASYSHARE Digital Display Software —manage your frame right from your computer, copy between your frame and computer (see [page 53](#)), and set up your frame for access to KODAK Gallery and Web content (see [page 12](#)).
- KODAK EASYSHARE Software —organize, edit, and share your pictures.

IMPORTANT: We recommend that you install both. If you already have EASYSHARE Software on your computer, upgrade to this special version for additional features.

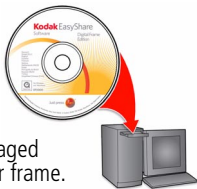

CD packaged with your frame.

- 1 Insert the CD into your computer, then follow the on-screen instructions to install the software.
 - Click Typical to install EASYSHARE Digital Display Software and to update a previous version of EASYSHARE Software.
 - If you do not have a previous version of EASYSHARE Software on your computer, you can click Custom and choose both applications for a new installation.

The software icons appear on your desktop when the installation is complete.

- 2 Double-click  to open EASYSHARE Digital Display Software if it doesn't open automatically.

When prompted, take a few minutes to electronically register your frame and software for exclusive tips and offers. To register later, visit www.kodak.com/go/register.

Verifying computer/device connections

Scanning to verify your wireless network connection gives your frame access to content on your devices wirelessly.

After installing the software (see [page 9](#)), return to your frame then:

1 Tap OK.

The network connection setup screen appears.



Scan later



Scan now

If you forgot to install the software, tap Back then install the software (see [page 9](#)). When you are done installing the software on your computer, tap OK on your frame, then continue with step 2.

2 Tap Scan now to verify your computer connection.

The Scanning screen appears as the frame scans your network and then lists available computers and other picture sources that your frame can access wirelessly.

You can select Scan later if you want to verify your connections later.

To verify your connections later, tap Home  → Settings  → Network → Verify computer connection.

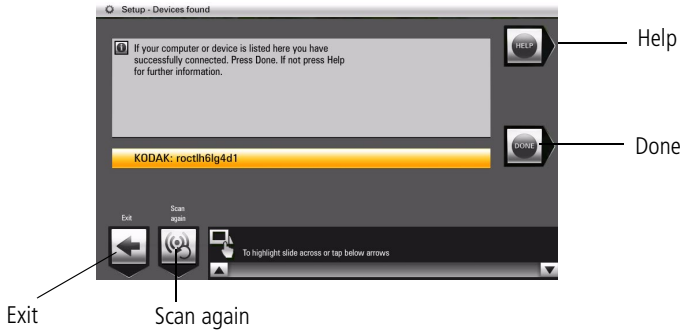

- 3 If your computer is listed, your wireless connection is successful. Tap Done to close the window.

If your computer is not listed, tap Scan again or tap Help for options.

You have completed the frame setup. Your frame can now access your host computer, wirelessly. Your computer appears as a picture source icon  on your frame's Home screen (see [page 30](#)).

- 4 Tap  (Home) to start viewing your pictures.

NOTE: If you have more than one frame or device on your wireless network, give them unique names using the on-screen keyboard so you can tell them apart. Go to Home → Settings → Device configuration menu, ([see page 59](#)).

3

Setting up Web content

Setting up access to the Gallery and Web media

IMPORTANT: *For Mac OS users, do not load the EASYSHARE Digital Display Software on your computer. See [page 15](#) to open your frame's Device Settings page in your browser to start setting access to Web content and customizing your frame from your computer.*

On your computer, use KODAK EASYSHARE Digital Display Software (see [page 12](#)) to set up access to the KODAK Gallery and RSS (Really Simple Syndication) feeds such as publicly posted images, news, weather, sports, finance, etc. Or, use the Settings option to customize your frame right from your computer.

WINDOWS OS users

- 1 Make sure your frame and computer are connected to your wireless network (see [page 5](#)) and your computer is connected to the Internet.
- 2 Click  on your desktop to open EASYSHARE Digital Display Software.
- 3 Select Enable media sharing to allow your frame to access pictures on your computer, then click Next.
- 4 Select Yes, set up Web media to access Web content such as KODAK Gallery, FLICKR, and FRAMECHANNEL, then click Next.
- 5 Click Device Settings next to the frame icon in the Drag and Drop Zone.
Your frame's Device Settings page opens in your browser.

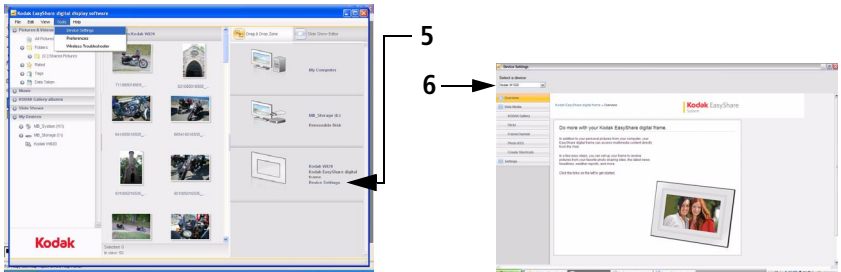

6 From the drop-down menu, select your frame.

7 Click the following Web Media pages for setup instructions to easily access content right on your frame:

- KODAK Gallery—connect to your existing Gallery account or set up a new one to receive pictures from other Gallery friends and family. See [page 16](#).
- FLICKR—sign in to your existing FLICKR account or set up a new one (see [page 17](#)) so you can receive and view FLICKR photos on your frame.
- FRAMECHANNEL—add to your list of RSS photo feeds from FRAMECHANNEL (see [page 21](#)) and receive photos from your favorite photo-sharing sites. Connect to your existing FRAMECHANNEL account or set up a new one (see [page 21](#)) so you can customize content such as news, weather, traffic, sports scores, finance, and much more.
- Photo RSS—add to your list of RSS photo feeds from FLICKR and other favorite photo-sharing sites (see [page 19](#)).
- Create shortcuts—create up to 5 shortcuts of your favorite photo feeds (see [page 25](#)).
- Settings—customize your frame with general settings, display settings, and clock and timer settings right from your computer. (For more details about the settings, see [Changing settings and more, page 57](#).)

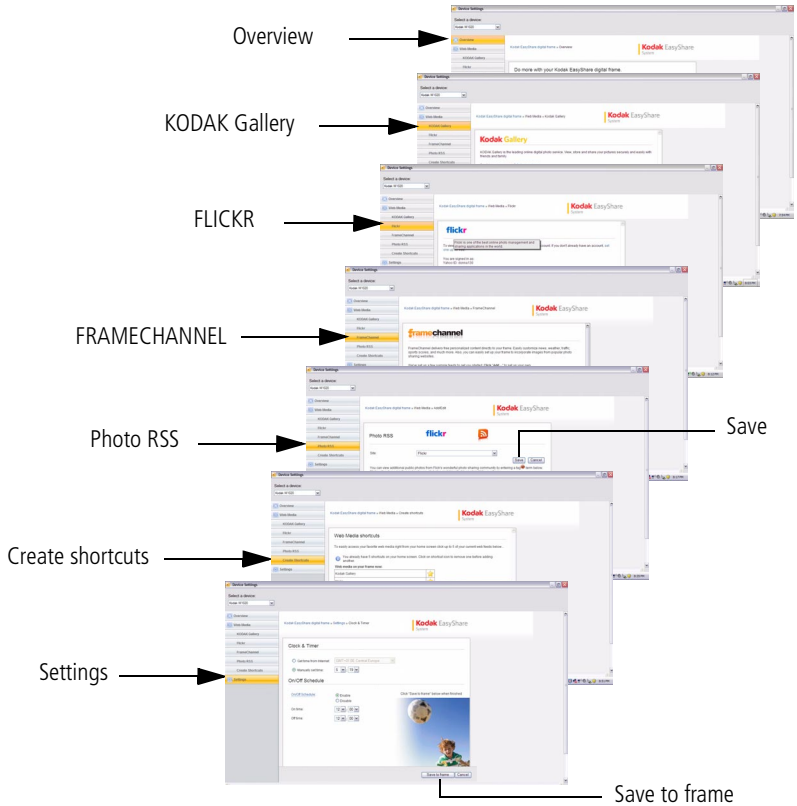

NOTE: Use the preview, edit, and delete features to manage your feed list quickly and easily (see [page 26](#)).

IMPORTANT: Make sure you click Save or Save to frame to save your entries.



MAC OS users

Instead of installing the software on your MACINTOSH Computer, open the Device Settings page right from your browser and start setting up access to Web content and customizing your frame from your computer.

- 1 Make sure the frame is connected to your wireless network (see [page 5](#)) and your computer is connected to the Internet.
- 2 On the frame, tap Home  → Settings  → Network, then tap Select.
- 3 Retrieve the IP address (format: XXX.XXX.X.XXX) from the frame's Network Settings screen.
- 4 Open a browser (for example, INTERNET EXPLORER, MOZILLA FIREFOX, SAFARI, etc.) on your computer.
- 5 Enter the IP address in the browser's address window, then press Enter.



Enter the IP address here

The KODAK Displays and Devices Configuration page opens in your browser.

- 6 Go to step 7 on [page 13](#) to start configuring your frame.

Connecting to your Gallery account

Perform this one-time setup on your frame to connect it to your existing KODAK Gallery account.

- 1 Follow the steps on [page 12](#) to access the Device Settings page.
- 2 Click the KODAK Gallery tab.
The KODAK Gallery Web Media configuration page appears.
- 3 If you don't have a Gallery account, click Set one up now. Follow the on-screen instructions, or visit www.kodakgallery.com, then continue with step 4.
- 4 Select your country/region from the drop-down menu.

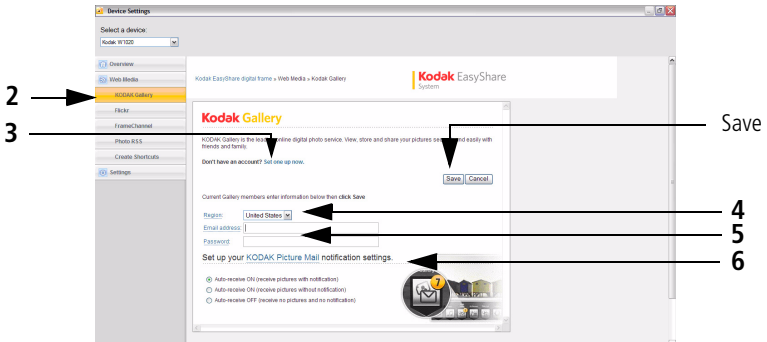

- 5 Enter the email address that is associated with your Gallery account, then enter your Gallery password.
- 6 Select a Picture Mail automatic notification setting to receive pictures on your frame from other Gallery members.
- 7 Click Save when you are finished.

Congratulations, you have completed your Gallery setup! KODAK Gallery is added to the Web Media list on your frame's Home screen (see [page 30](#)). To create a KODAK Gallery shortcut on the Home screen, see [page 25](#).

Connecting to your FLICKR account

To view your FLICKR photos on your digital frame, you need a FLICKR account.

- 1 Follow the steps on [page 12](#) to access the Device Settings page.
- 2 Click the FLICKR tab.

The FLICKR Web Media configuration page appears.

- 3 If you don't have a FLICKR account, click Set one up. Follow the on-screen instructions to create an account.
- 4 If you have an account, click Sign in now.

The FLICKR authorization window appears if you logged into a valid account. You can now click on the Photo RSS tab to view and add photo feeds (see [page 19](#)).

- 5 If you did not sign into a valid account and you want to change to a different FLICKR account, click Unauthorize.

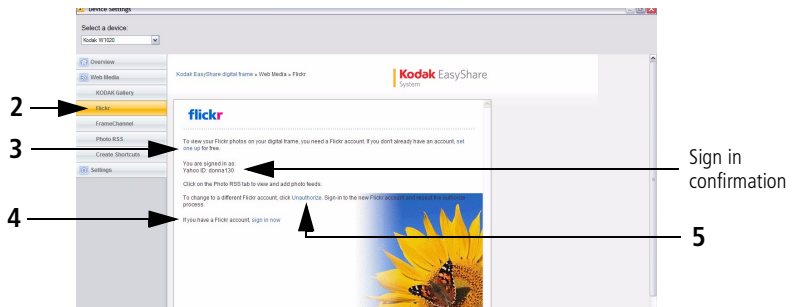

- 6 After setting up your FLICKR account, click OK, I'll allow it so your frame can access FLICKR photo feeds wirelessly.

You return to the FLICKR Web Media page with your sign in confirmation.

- 7 You can now view photo feeds from FLICKR (see [page 46](#)).

Connecting to your FRAMECHANNEL account

Creating an account links FRAMECHANNEL to your frame so you can view, create, and manage additional customized feeds such as health, finance, and much more.

- 1 Follow the steps on [page 12](#) to access the Device Settings page.
- 2 Click the FRAMECHANNEL tab.
The FRAMECHANNEL Web Media configuration page appears.
- 3 If you don't have a FRAMECHANNEL account, click the link to create an account. Follow the on-screen instructions.

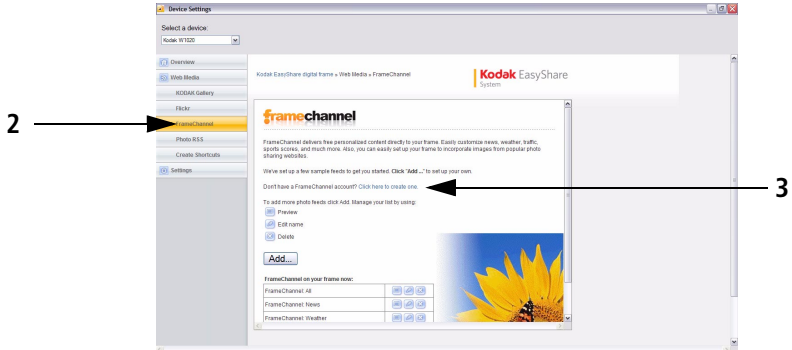

- 4 When you are finished setting up your FRAMECHANNEL account, or if you already have one, sign in, then enjoy the benefits of having an account:
 - access and customize free photo-sharing sites, and add them to your frame for viewing
 - preview contents of your frame right on the FRAMECHANNEL page
 - view and manage your favorite photos and photo-sharing sites

Adding Web feeds

Set up your frame to view RSS (Really Simple Syndication) photo feeds directly from FLICKR, FRAMECHANNEL, and other favorite sites.

IMPORTANT: *Your frame can play only feeds that contain photos. An error message appears when you try to play feeds that are text only. Make sure you preview your feeds after they are added to the Web Media configuration page where you can edit or delete them. See [page 26](#).*

NOTE: Preloaded feeds and new feeds are added to the Device Settings Web Media list (where you can preview, edit, or delete them, see [page 26](#)). They appear also in the Web Media list on your frame's Home screen where you can play them (see [page 30](#)).

How to add a FLICKR feed

- 1 Follow the steps on [page 12](#) to access the Device Settings page.
- 2 If you don't have a FLICKR account, create one now (see [page 17](#)), then continue with step 3 below.
- 3 Click the Photo RSS tab.

The Photo RSS/FLICKR Device Settings page appears with a list of preloaded FLICKR feeds that are on your frame.

- 4 Click Add.

The Photo RSS/FLICKR Add/Edit page appears.

NOTE: You can edit preloaded feeds here (such as Flickr: Interesting photos) and feeds you add. (See [page 26](#).)

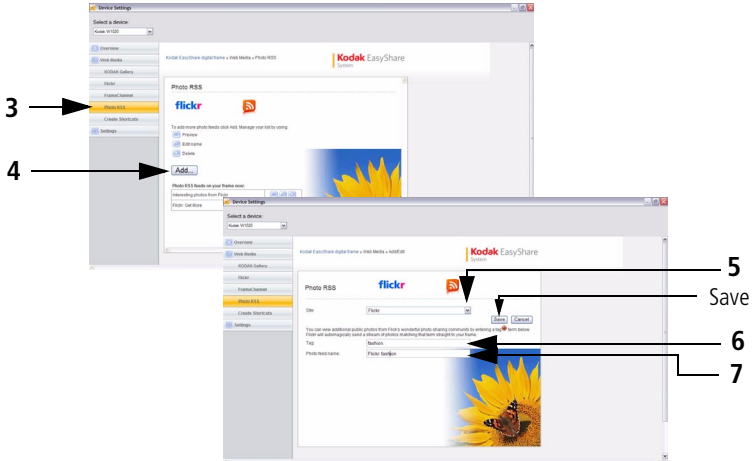

- 5 In the Site drop-down menu, keep FLICKR as the default site.
- 6 Enter a tag (keyword) for the types of photos you want to see.
NOTE: FLICKR automatically sends pictures matching the tag (keyword) directly to your frame.
- 7 Click in the Photo feed name box to automatically assign the tag to the FLICKR feed name.
- 8 Click Save.

Congratulations, you have completed your FLICKR photo feed setup! The feed name is added to the list of feeds on the FLICKR configuration page and to the Web Media  list on your frame's Home screen. (See [page 30.](#)) To create a shortcut of your feed on the Home screen, see [page 25.](#)

NOTE: Preview your feed to make sure it will play on your frame. (See [page 26.](#))

How to add a FRAMECHANNEL feed

1 Follow the steps on [page 12](#) to access the Device Settings page.

2 Click the FRAMECHANNEL tab.

The FRAMECHANNEL Web Media configuration page appears with a list of preloaded FRAMECHANNEL feeds that are on your frame.

3 If you don't have a FRAMECHANNEL account, click the link and follow the on-screen instructions to create one.

IMPORTANT: *Creating an account links FRAMECHANNEL to your frame so you can view, create, and manage additional customized feeds such as sports scores, health, finance, and much more. You can click the FRAMECHANNEL logo to access these and other free photo-sharing sites for viewing right on your frame.*

4 Click Add.

The FRAMECHANNEL Add/Edit page appears.

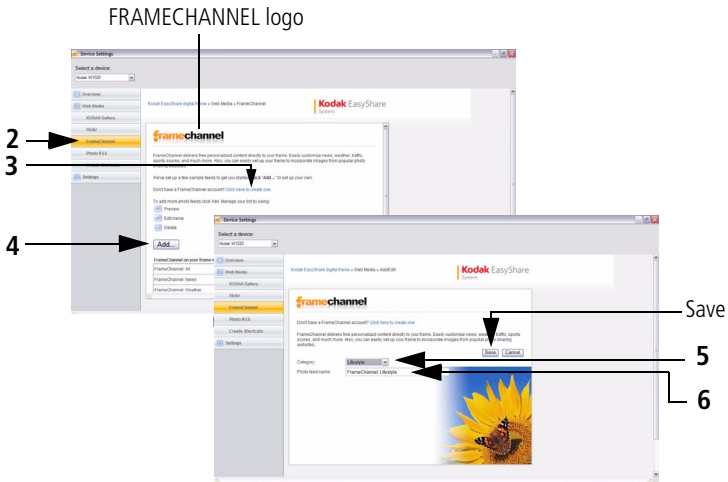

- 5 From the Category drop-down menu, select the type of content you want to see from FRAMECHANNEL (news, weather, sports, finance, etc.)
- 6 You can change the photo feed name (category included) that appears automatically.
- 7 Click Save.
- 8 Congratulations, you have completed your FRAMECHANNEL photo feed setup! Your feed is added to the list of FRAMECHANNEL feeds on the configuration page and to the Web Media  list on your frame's Home screen. (See [page 30](#).) To create a shortcut of your feed on the Home screen, see [page 25](#).

NOTE: Preview your feed to make sure it will play on your frame. (See [page 26](#).)

How to add feeds from other sites

- 1 Follow the steps on [page 12](#) to access the Device Settings page.
- 2 Click the Photo RSS tab.

The Photo RSS/FLICKR Device Settings page appears with a list of preloaded feeds that are on your frame.

- 3 Click Add.

The Photo RSS/FLICKR Add/Edit page appears.

NOTE: You can edit preloaded feeds here (such as Flickr: Interesting photos) and feeds you add from other sites. (See [page 26](#).)

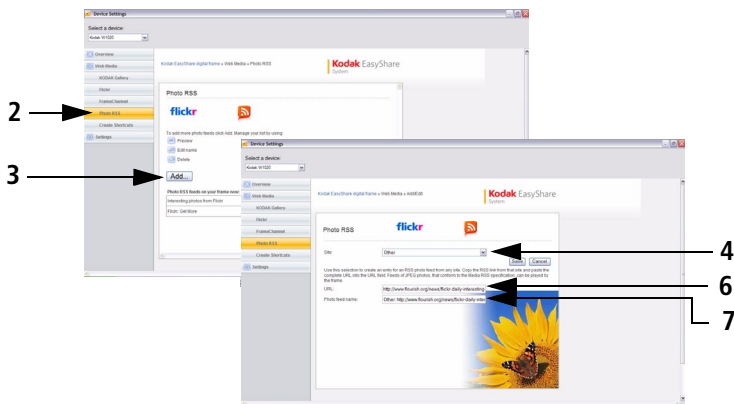

- 4 From the Site drop-down menu, select Other.
- 5 In a new window on your computer, navigate to a photo RSS feed on the Internet.
- 6 Highlight the complete RSS feed URL in the address bar, then copy and paste it into the URL box on the Web Media Add/Edit page.
- 7 Click in the Photo feed name box to automatically generate the feed name.

Change the name, if desired, by clicking the feed name and entering a new one.

8 Click Save.

Congratulations, you have completed your photo feed setup! The feed name is added to the list of feeds on the Web Media Configuration page (see [7](#)) and also in the Web Media  list on your frame's Home screen. (See [page 30](#).) To create a shortcut of your feed on the Home screen, see [page 25](#).

NOTE: Preview your feed to make sure it will play on your frame. (See [page 26](#).)

Creating shortcuts on your frame

Create up to five shortcuts to easily access your favorite Web media (such as KODAK Gallery, FLICKR, and FRAMECHANNEL) right from your frame's Home screen.

- 1 Follow the steps on [page 12](#) to access the Device Settings page.
- 2 Click the Create Shortcuts tab.

The Web Media shortcut page appears with a list of photo feeds (including feeds you create as shortcuts) that are on your frame.

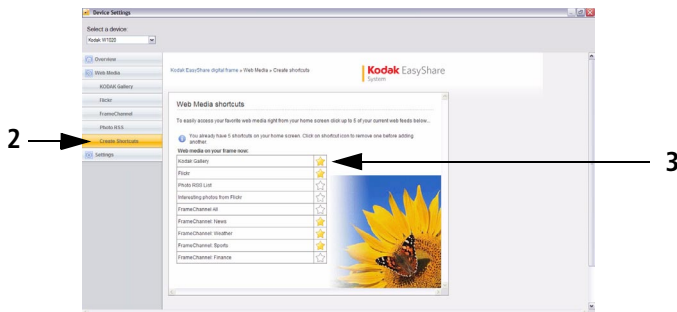

- 3 Click the icon  next to the feed you want to create as a shortcut (five shortcuts, maximum).

The icon is highlighted  and the shortcut to the feed immediately appears on the Home screen (see [page 30](#)).

To remove a feed as a shortcut, click the highlighted icon to disable it.

The shortcut is removed from your frame's Home screen.

Removing the shortcut only deletes the icon from the Home screen; it does not remove the feed from the list or from the Web Media list on the frame's Home screen.

Previewing, editing, and deleting feeds

Preview, edit, or delete feeds that are preloaded or that you add to the Web Media configuration list to play on your frame.

IMPORTANT: *Your frame plays only feeds that contain photos. An error message appears when you try to play feeds that are text only. Make sure you preview your feeds after they are added on the Device Settings Web Media page.*

To preview a feed, click  next to the feed name on the Web Media configuration page.

To edit a feed, click  next to the feed name.

- For FLICKR feeds, the tag name is highlighted and the text is erased when you type the first character of the new tag name.
- For FRAMECHANNEL feeds, you can select another category or change the photo feed name that is associated with the category.

To delete a feed, click  next to the feed name. A confirmation message appears for the deletion. Click OK.

Setting up Web content

The image shows two overlapping windows from the Kodak EasyShare software. The top window is titled 'Photo RSS' and shows a sidebar with 'Photo RSS' selected. The main content area displays the Flickr logo and an RSS icon, with instructions to add more photo feeds. Below the instructions is a table with one row: 'Photo RSS feeds on your frame now: Interesting photos from Flickr'. To the right of this row are three icons: a preview icon, an edit icon, and a delete icon. The bottom window is titled 'FrameChannel' and shows a sidebar with 'FrameChannel' selected. The main content area displays the framechannel logo and instructions to add more photo feeds. Below the instructions is a table with three rows: 'FrameChannel: id', 'FrameChannel: news', and 'FrameChannel: weather'. Each row has three icons: a preview icon, an edit icon, and a delete icon. Three callout boxes with arrows point from the 'Preview', 'Edit', and 'Delete' icons in the top window to the corresponding icons in the bottom window.

Preview

Edit

Delete

4

Viewing on your frame

Enjoying your pictures immediately!



- **To view your pictures or play a slide show,** insert a memory card, or connect a camera or other USB device (see [page 29](#)). Your pictures play automatically.

If your frame has pre-loaded sample pictures, they start playing automatically.

To maximize your frame's internal memory, delete the pre-loaded samples. Access them on My Frame (see [page 30](#)), then see [page 42](#) to delete them.

If you are at the Home screen, see [page 30](#) to start your slide show. To change the order, see [page 36](#).

Inserting a memory card

To insert a card (sold separately), push the card firmly into the slot until it stops.

To remove a card from:

- top card slot - push in the card to release it
- side card slot - pull out the card

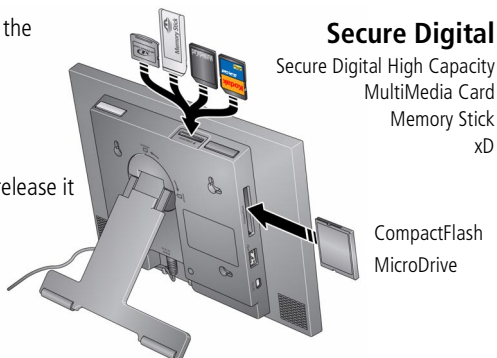

IMPORTANT: Do not insert a micro or mini memory card without an adapter.

Connecting a digital camera or other USB device

USB devices: camera, flash drive, card reader, computer, etc. (sold separately)

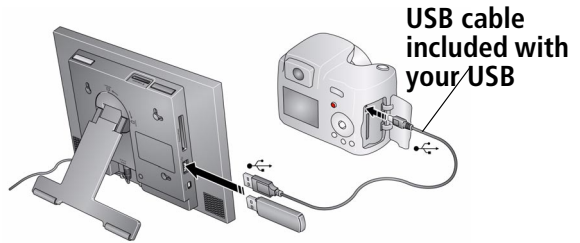

Viewing the Home screen

Start at the Home screen to:

- access your pictures, videos, music, and preloaded FRAMECHANNEL photo feeds such as news, weather, sports
- view Web media content from KODAK Gallery, FLICKR, FRAMECHANNEL, and other photo-sharing sites
- customize your viewing through the Settings screens



If the icons are not visible, tap the Quick Touch Borders.

Tap the border below one of the icons along the bottom of the screen.

Tap Close to dismiss the icons.

Home screen icons:



Pictures and videos (see [Accessing your pictures and videos, page 32](#))



Music (see [Playing music, page 37](#))



Web Media—list of all photo RSS feeds that are on your frame.

You can add new or edit preloaded feeds in the Web Media configuration pages (see [page 19](#)).



KODAK Gallery—appears if you set up access (see [page 16](#)) and create the Gallery as a shortcut (see [page 25](#)). If you did not create a shortcut, find KODAK Gallery listed in Web Media above. Display your Gallery albums and My Friends' Albums. This icon () indicates someone has shared pictures with you at the Gallery! See [page 49](#).



FLICKR—preloaded (including Interesting photos from FLICKR) and new FLICKR feeds you set up (see [page 19](#)).



FRAMECHANNEL—appears if you create shortcuts for FRAMECHANNEL feeds from favorite photo-sharing sites (see [page 21](#)).



News—Preloaded feed from FRAMECHANNEL that you can manage or customize (see [page 21](#)).



Weather—Preloaded feed from FRAMECHANNEL that you can manage or customize (see [page 21](#)).



Sports—Preloaded feeds from FRAMECHANNEL that you can manage or customize (see [page 21](#)).





Settings—customize frame settings such as viewing options, clock and timer, verifying network connections, screen brightness, etc. For details, see [page 57](#).

Accessing your pictures and videos



Picture source icon

- 1 Tap  (Home), then  (Pictures and Videos).

All connected sources are displayed.

- 2 Slide or tap below the arrows to highlight a picture source, then:

- Tap  (Play slide show) on the right border to start a slide show of the pictures in the highlighted source.
- Or, tap OK to view thumbnails, folders, etc.

Picture sources:



Internal memory—the frame's 512 MB internal memory. Copy your pictures into My Frame from a memory card or other device.



Memory card—appears when you insert a card (see [page 28](#)). The label and icon indicate the type of card.



Camera—appears when you connect a digital camera via USB cable (see [page 29](#)).



USB drive—appears when you insert a USB flash drive (see [page 29](#)).



Home computer—appears if you are connected to a wireless network computer (see [page 5](#)). Display pictures that are stored on the computer.



My Slide show—appears when you save a favorite slide show source for quick access anytime (see [page 35](#)).

Viewing pictures and videos

View pictures and videos from the frame's internal memory or any connected picture source (see [page 32](#)).

IMPORTANT: *For wireless access, make sure you set up your frame to work with your wireless home network (see [page 5](#)). See also [Viewing pictures/videos wirelessly, page 45](#).*

Viewing thumbnails (multi-up)

There are two ways to view your pictures as thumbnails:







- Tap (Home) → (Pictures and Videos), then select a picture source, ([see page 32](#)). Tap OK.
OR,
- From a slide show (tap the touch border to display the icons) or from single view, tap (Thumbnails).



To navigate through the thumbnails, slide your finger left/right along the slider at the bottom. To move even faster through the thumbnails, touch and hold until the screen changes (about 3 seconds).

To play a folder of thumbnail (multi-up) images, highlight the folder then tap (Play slide show).

Viewing a single picture

- **To view a single**, full-screen picture, highlight it in thumbnails view, then tap OK. If a slide show is playing, tap the border (upper right or bottom) when the picture appears, then tap  (Close) to hide the icons and lights and view full screen.
- **To magnify** a picture up to 8X, tap  (Actions), then tap  (Zoom). Slide under the zoom bar from left to right towards the plus (+) sign. To view other parts of the magnified picture, tap the arrows . To return to 1X, slide from right to left towards the minus (-) sign.

NOTE: The zoom level depends on image size. You can zoom more with larger images.

- **To rotate** a picture, tap  (Actions), then keep tapping  (Rotate) until you get the desired orientation.

Playing a slide show

There are two ways to start a slide show on your frame:

- Insert a card or connect a USB device—a new slide show starts automatically, replacing a currently running slide show or single view picture.
- Highlight a picture folder in thumbnails view (see [page 33](#)), or highlight a picture source on the Pictures and Videos screen, then tap  (Play slide show).

NOTE: Music and videos in the same picture source play automatically during a slide show.

To add music to a slide show, see [page 37](#).

Other slide show information

- A slide show plays continuously until you tap a Quick Touch Border to stop it or turn off the frame.
- While viewing a slide show, you can change your slide show settings. Tap a Quick Touch Border to display the icons, then tap  (Slide show options) to see the settings. For more details about the settings, see [page 58](#).
- Set your frame to play sound from a captured video, or play music (if available and selected) when videos are played. See Audio priority in Settings, [page 57](#).

Saving your favorite slide show for easy access

Save access to favorite pictures as My Slide show. While viewing a slide show:

- Tap a Quick Touch Border to pause the slide show and to display the screen icons.
- Tap  (Slide show options) → Save as My Slide show. Tap Yes to confirm.

NOTE: My Slide show plays automatically when you turn on your frame. The My Slide show icon  appears on the Pictures and Videos screen as a picture source, (see [page 32](#)).

Arranging pictures to play by date or filename

The pictures on your frame are arranged and played by date, starting with the oldest. You can play the arrangement or order by date, newest to oldest, or alphabetically by filename.

To change the sort order:

- 1 While viewing a slide show, tap a border to display the icons, then tap  (Slide show options).
- 2 Highlight Sort, then tap Select.
- 3 Highlight a sort order:
 - Filename, A to Z
 - Filename, Z to A
 - Date, oldest to newest
 - Date, newest to oldest
- 4 Tap Save.



5

Doing more with your frame

Playing music



▶ Play/Pause button

- 1 Tap  (Home), then  (Music). Slide to highlight a music source then tap OK.
- 2 Slide to the right/left to move up/down the music source list, then tap OK.
- 3 Slide right/left to go to the previous/next song, or tap Select all, then tap the Play button on the bottom of the border to start playing music.

Tap  (Audio Options) at the bottom to turn on/off Shuffle Play and to set Audio Priority. For more details, see [page 57](#).

- 4 Tap  (Play slide show) on the right border to return to your slide show.

NOTE: Music plays automatically when a memory card or USB device with music on it is connected. To prevent music from playing automatically, tap Home > Settings > Viewing Options > Music auto-play > Off.





Notes on playing, copying, deleting music:

- To add background music while a slide show is playing, touch the border to display the icons. Tap  (Slide show options) > Background music, then tap Select.
- A headphone jack is available on the side of the frame (see [page i](#)).
- Adjust the frame volume with the Volume button (see [page ii](#)). The on-screen volume indicator appears in the upper right corner.

- To copy or delete music files (MP3), highlight the songs in the music source, then tap  (Actions) → Copy or Delete → OK.
 - To copy, tap under the destination icon where you want to copy your music.
 - To delete, tap Yes to confirm the deletion.
- To copy music files (MP3) from your computer to your frame's internal memory, drag and drop them from your computer. See [Copying wirelessly to/from your computer](#), page 53.

Playing a video

- During a slide show, videos play automatically. When the video ends, the slide show advances to the next picture or video. To play a video from thumbnails view, highlight a video thumbnail, then tap OK.
- Videos in thumbnail view:
 - MOV videos are indicated with .
 - AVI, MPEG, and MPG videos display the first frame.
- Video control icons (on bottom border):

	play, pause, and resume the video.
	rewind / fast forward.
 or 	stop the video and return to thumbnails.

NOTE: HD (high definition) video files are not supported. Video formats created with digital cameras are certified for KODAK Digital Frames. Videos created with or copied from other sources may not play on your frame.

NOTE: To play the audio portion of a video while you are playing music, change the Audio priority in Viewing options, ([see page 57](#)).

Printing pictures

NOTE: The print icon is available on your frame when you connect your printer.

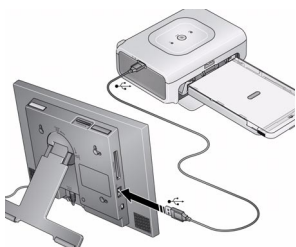

Your frame is compatible with PICTBRIDGE Technology, so you can print directly to PICTBRIDGE enabled Printers.



- 1 Turn off the frame and printer.
- 2 Make sure your frame is disconnected from the printer.
- 3 Turn on the frame, then change your connection mode on your frame from Computer to Printer. See [page 40](#).
- 4 Reconnect your frame to the printer, using the USB cable.

Printing to a PictBridge enabled Printer

- 1 Turn on the printer. Turn on the frame.
- 2 From a slide show (tap the touch-sensitive border to pause the slide show and display the icons) or from single view:

- Tap  (Actions), then  (Print).

Printing of the displayed picture begins.

If you are in thumbnails (multi-up) view:

- Slide to select a picture, or see [page 43](#) to select multiple pictures.
- Tap  (Actions).



If you selected multiple pictures to print, the pictures and number of selected pictures appear on the screen.

- Tap  (Print), then Yes to start printing all selected pictures.

NOTE: Remember to change your connection mode back to Computer when you are done (see [page 40](#)).

Manually changing USB connection mode

The connection mode must match the device you connect the frame to: Computer or Printer. The default is Connect to computer. You can change the connection mode manually.

- 1 Disconnect the printer or computer from the frame.
- 2 On the frame, tap  (Home).
- 3 Tap  (Settings).
- 4 Slide to highlight Device configuration, then tap Select.
- 5 Highlight USB connection mode, then tap Select.
- 6 Slide to highlight the mode you want to connect to, printer or computer, then tap Save.
- 7 Reconnect the device (printer or computer) that matches the connection mode in step 6.

Copying on your frame

Copy pictures from your current viewing location to other connected devices (see [page 29](#)).



CAUTION:

Removing a card or disconnecting a device while copying may damage your card, pictures, or device.



- 1 Highlight a picture to copy:
In thumbnails view, slide or tap below the slider arrows to find a picture; or, display a picture in single view (see [page 33](#)).

- 2 Tap  (Actions).

- 3 Tap  (Copy).

- 4 Tap under the destination icon where you want to copy your picture.

The picture is copied.

- 5 Tap Close to dismiss the screen.

To copy multiple pictures, see [page 43](#).



NOTE: To copy wirelessly between your frame and computer, see [page 53](#).

Deleting pictures



CAUTION:

Removing a card or disconnecting a device while deleting may damage your card, pictures, or device.



- 1 Highlight a picture to delete:
In thumbnails view, slide or tap below the slider arrows to find a picture; or, display a picture in single view (see [page 34](#)).

- 2 Tap  (Actions).

- 3 Tap  (Delete), then tap Yes to confirm.
The picture is deleted.

- 4 Tap Close to dismiss the screen.
To delete multiple pictures, see [page 43](#).

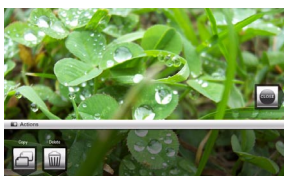

Selecting multiple pictures

Use the multi-select feature to copy or delete two or more pictures or to play a slide show of selected pictures.

- 1 In thumbnails view (see [page 33](#)), slide or tap below the slider arrows to find a picture, then tap  (Select).

A check mark appears on the selected picture.

- 2 Continue selecting pictures.

To remove a check mark, tap  (Unselect) while the picture is highlighted.

Select/Unselect all



Select all

- In thumbnails view (see [page 33](#)), tap  (Select All).

Unselect all

- To remove all check marks, tap Unselect All



6

Using wireless mode

For more information on wireless setup, operation, and networks, see [Setting up for wireless operation, page 5](#) or visit www.kodak.com/go/wifisupport or www.wi-fi.org.

What are the wireless features of my frame?

Connect to your home wireless network and:

- Display pictures on your frame directly from your computer hard drive (see [page 45](#)).
- Display Web content you set up (see [page 46](#)).
- Display pictures from your KODAK Gallery account (see [page 47](#)).
- Automatically receive pictures from your friends and family at the Gallery (see [page 49](#)).
- Copy pictures wirelessly from your frame to your computer (see [page 53](#)).
- Automatically upgrade your firmware from the Internet (see [page 63](#)).

Setting up your frame for wireless operation

See [Installing the software: WINDOWS OS only, page 9](#) and [Connecting to your wireless network, page 5](#) for detailed instructions about your software application and setting up your frame.

Do you have security enabled on your wireless network? If so, have your network name and security key (WEP or WPA) available. (See [page 7.](#))

Wireless networking and the Internet

Some wireless functions on your frame, including viewing pictures on KODAK Gallery (see [page 47](#)), require access to the Internet.

Viewing pictures/videos wirelessly



Wirelessly view pictures and videos from your computer right on your frame using the KODAK EASYSHARE Digital Display Software.

Before you proceed:

- 1 Make sure you install the software packaged with your frame (see [page 9](#)). Connect to your wireless home network (see [page 5](#)), then verify your computer connection (see [page 10](#)).

Your frame can now access the content on your host computer, wirelessly. Your computer appears as a picture source icon  on your frame (see [page 30](#)).

NOTE: If you have more than one frame on your wireless network, give them unique names using the on-screen keyboard so you can tell them apart. Go to Home → Settings → Device configuration menu. (See [page 59](#).)

- 2 On your frame, tap  (Home) →  (Pictures and Videos).

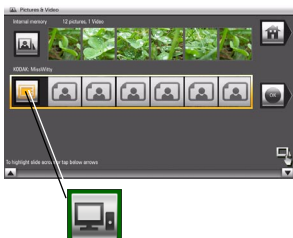

- 3 Highlight your home computer () , then tap OK. *It may take up to 10 seconds for your Network Computer to appear on the Home screen.*

If your network computer is not listed on the Home screen, go to troubleshooting help on [page 67](#).

NOTE: The first time you connect, a message may appear on your computer screen alerting you to a new device. Follow the prompts to "allow" the frame on your computer.

- 4 Highlight the category of pictures (such as Pictures and Videos, StoryShare Albums, and New Picture Chronicles) that you want to view, then tap OK.

All Pictures and Videos displays every picture and video that your computer is sharing, without showing folders. The categories are established by the EASYSHARE Digital Display Software (see [page 53](#)).



- 5 Pictures are displayed as thumbnails. See [Chapter 4, Viewing on your frame](#) for all the ways you can enjoy your pictures, videos, and music on your frame.

Viewing Gallery/Web media content on your frame

- Play slide shows of KODAK Gallery albums (see [page 47](#)).
- Play slide shows of photo RSS (Really Simple Syndication) preloaded feeds or ones you set up (see [page 48](#)).
- Receive pictures from your friends and family at the Gallery (see [page 49](#)).



- 1 See [page 12](#) to set up your frame for Web access.
- 2 Tap  (Home) to display the Home screen.
- 3 Tap one of these Web sources:



Web Media—list of all the RSS photo feeds that are on your frame.

You can add new or edit preloaded feeds in the Web Media configuration pages (see [page 19](#)).



KODAK Gallery—appears if you connect to your Gallery account (see [page 16](#)) and create a shortcut (see [page 25](#)). If you did not create a shortcut, find KODAK Gallery listed in Web Media above. Display your Gallery albums and My Friends' Albums. This icon () indicates someone has shared pictures with you at the Gallery!

See [page 49](#).



FLICKR—preloaded (including Interesting photos from FLICKR) and new FLICKR feeds you set up (see [page 19](#)).



FRAMECHANNEL—appears if you create shortcuts for FRAMECHANNEL feeds from favorite photo-sharing sites (see [page 21](#)).



News—Preloaded feed from FRAMECHANNEL that you can manage or customize (see [page 21](#)).



Weather—Preloaded feed from FRAMECHANNEL that you can manage or customize (see [page 21](#)).



Sports—Preloaded feeds from FRAMECHANNEL that you can manage or customize (see [page 21](#)).





Viewing KODAK Gallery pictures

View Gallery pictures and albums wirelessly right on your frame.

IMPORTANT: *First, set up access to KODAK Gallery. See [page 12](#).*

NOTE: Connection to KODAK Gallery is currently limited to customers in the United States, Canada, and Europe.

To see all pictures from the Gallery:

- 1 Tap  (Home) →  (KODAK Gallery), if you created a Gallery shortcut (see [page 25](#)). Otherwise, on the Home screen, tap  (Web Media) → KODAK Gallery → Select.
- 2 Highlight Your Album, then tap OK.
- 3 Highlight Play all, then tap OK to see the pictures as thumbnails. Or, tap  (Play slide show) to view them as a slide show.

See [page 28](#) for all the ways you can enjoy your Gallery pictures on your frame.

NOTE: Features not supported from the Gallery at this time: viewing videos, printing and deleting pictures.



Viewing Web feeds on your frame

Wirelessly view preloaded RSS feeds or feeds you set up (see [page 19](#)) of frequently changing Web content such as FLICKR or FRAMECHANNEL public photos, news, weather, sports, finance, etc.

- 1 From the Home screen, tap a shortcut feed you set up (see [page 25](#)) or a preloaded one such as News, Weather, and Sports (see [page 30](#)).

The slide show begins.

Or,

- tap  (Web Media)
- slide to highlight the type of feed (such as FLICKR, FRAMECHANNEL, or other Photo RSS feeds), then tap Select
- slide to highlight a photo feed, then tap  (Play slide show) to play it

- 2 To pause a slide show and display the icons, tap a touch-sensitive area on the borders (upper right or bottom) during the slide show.

To hide the icons and lights and view the full screen, tap  (Close).

To restart the slide show, tap a touch-sensitive area on the borders (upper right or bottom) to display the icons, then tap  (Play slide show).

Automatically receiving My Friends Albums

Your wireless frame uses KODAK's Picture Mail feature to notify you automatically when a friend shares pictures with you at the KODAK Gallery. Play a slide show of the new pictures, right on your frame, even before you see the email on your computer!

To see the shared pictures right away:







- When the notice  appears on the frame screen, tap below View now.

A slide show of the new pictures plays on your frame. If there are multiple albums you haven't viewed yet, select a marked album  from the Gallery list and tap OK.

To see the shared pictures later:





- 1 When the notice  appears on the frame screen, slide to choose Dismiss.
- 2 To see the new pictures, tap  (Home) →  (KODAK Gallery), if you created a Gallery shortcut (see [page 25](#)). Otherwise, on the Home screen, tap  (Web Media) → KODAK Gallery → Select.
- 3 With My Friends' Albums highlighted, tap OK.
- 4 To view a My Friends album as a slide show, highlight the album, then tap  (Play slide show). Or, tap OK to see the pictures as thumbnails.

Turning off auto-receive and notification

You can turn off auto-receive and/or notification from your friends' albums at the Gallery from the Home screen (see below) or from the Device Settings page (see [page 12](#)).

- 1 Tap Home , Settings , then tap OK.
- 2 Tap KODAK Gallery, then tap Select.
- 3 Highlight Picture Mail, then tap Select.
- 4 Choose from these options:

Auto-receive with notification ON—(default) you automatically receive your friends' albums and the notice appears on the frame.

Auto-receive ON—you automatically receive your friends' albums, but the notice does not appear on the frame. You know when your friends send you pictures because the email icon still appears on the KODAK Gallery on the Home screen  and on unviewed My Friends' Albums in your Gallery account .



Auto-receive OFF—you don't automatically receive your friends' albums on your frame. To view them, see [Viewing KODAK Gallery pictures, page 47](#).

Emailing pictures and videos from your frame

Select pictures or an album on your frame then share them wirelessly via Email. First, add the person's email address to your share list and assign an optional nickname.

IMPORTANT: Make sure you install the software that came with your frame (see [page 9](#)) and connect your frame to your wireless home network (see [page 5](#)).

Adding a new email address

- 1 Choose a picture source then tap  (Actions).
- 2 Tap  (Share) → Add name.
- 3 Use the keyboard to enter the email address, then tap Save.

Enter the email address

Slide along the bottom of the touch border (or tap the slider arrows) to highlight a character then tap  (Select). The character appears in the text box. Tap Save when you are finished.

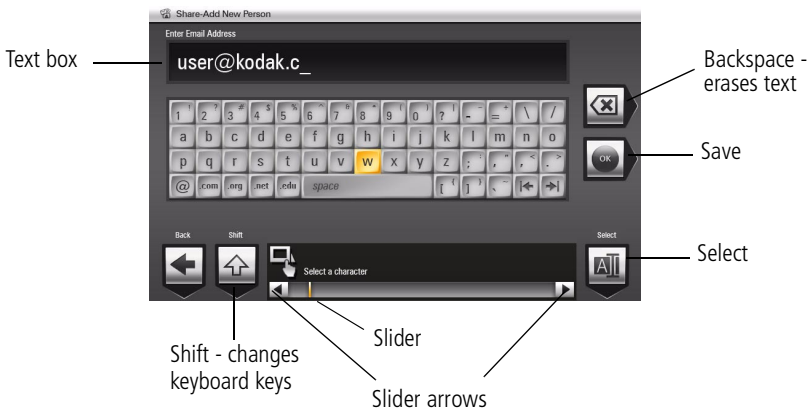

- 4 Assign a nickname to the new email address (optional).

Sharing your pictures

- 1 Highlight a picture to share:

In thumbnails view (see [page 33](#)), slide or tap below the slider arrows to find a picture; or, display a picture in single view (see [page 34](#)).

- 2 Tap  (Actions).



- 3 Tap  (Share).

A list of email addresses and nicknames you created appear. The album name and number of pictures to share are also displayed.

- 4 Slide to highlight an email address. Or, tap Add name to add a new email address to your share list (see [page 51](#)).

- 5 Tap  (Share).

To send the pictures to more than one address, highlight each address then tap

 (Select). Tap  (Select all) to send to everyone on your list.

A progress bar of the number of shared pictures and the upload destination appears. If the destination is your Gallery account, the entire album is uploaded.

Copying wirelessly to/from your computer

The KODAK EASYSHARE Digital Display Software (included on the CD that was packaged with your frame) lets you drag and drop (copy) pictures, videos, and music wirelessly between your frame and computer or other connected devices (see [page 29](#)).

Before you proceed:

- 1 Make sure you install the software packaged with your frame (see [page 9](#)). Connect to your wireless home network (see [page 5](#)), then verify your computer connection (see [page 10](#)).

Your frame can now access the content on your host computer, wirelessly.

NOTE: If you have more than one frame on your wireless network, give them unique names so you can tell them apart. Go to Home → Settings → Device configuration menu. (See [page 59](#).)

- 2 Make sure the USB connection mode on your frame is set to Computer (see [page 40](#)).

- 3 Double-click  (KODAK EASYSHARE Digital Display Software icon) on your desktop to open the software.

The frame, memory card, and connected devices (see [page 29](#)) appear in the Drag and Drop Zone.

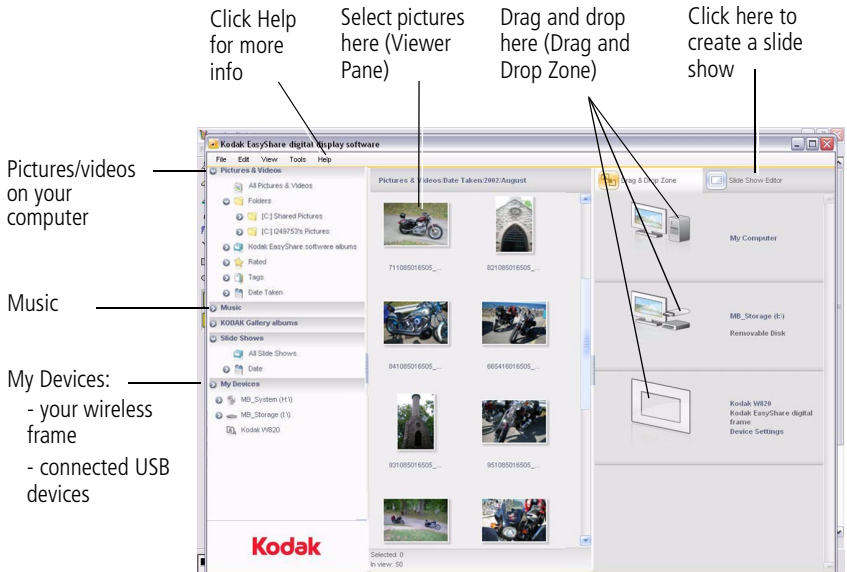

- 4 Click My Devices to see the folders on your frame and connected devices (see [page 29](#)).

The frame appears as removable drives—one drive for each picture source on the frame's picture source: internal memory (My Frame), and any inserted memory cards or connected devices.

- 5 Click Pictures and Videos or My Devices to find the pictures, videos, etc. you want to copy.
- 6 In the Viewer pane, select the pictures, videos, etc., then drag and drop them to the new location in the Drag and Drop Zone (for example, the frame's internal memory, a memory card, computer, or connected USB device).
- 7 Go to the copy location to view your copied pictures, videos, etc. or to play a slide show on your frame.

NOTE: The slide show order of play for available sources is: memory card, USB device, internal memory.

NOTE: To maintain the slide show order during playback, see [page 36](#) and select Filename, A - Z.

Copying pictures from EASYSHARE Software

It's easy to copy pictures/videos from My Collection to your frame.

- 1 Install the software that came with your frame (see [page 9](#)).
- 2 Set the USB connection mode to Computer (see [page 40](#)).
- 3 Double-click  (KODAK EASYSHARE Software) on your desktop to open the software.
- 4 Click My Collection, then select the pictures in the Viewer pane. Drag and drop them into the Picture tray.
- 5 In the menu bar, select File → Copy to.

The frame appears as removable drives—one drive for each connected picture source in the frame: internal memory, memory cards, USB devices.

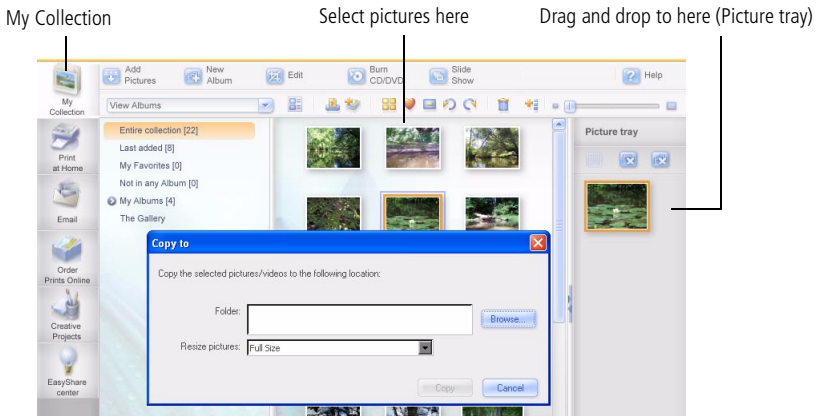

- 6 Browse to the frame location to which you are copying.



- 7** Select *Best For Digital Picture Frame* to resize the picture you are copying. Full resolution is unnecessary and quickly fills up the frame's memory.
- 8** Click Copy. Pictures are copied to your frame.
- 9** Go to the copy location to view your copied pictures on your frame and to play a slide show.

7

Changing settings and more

Changing frame settings

The options in the Settings menu let you customize and configure your frame.

1 Tap  (Home), then  (Settings).

2 Slide or tap below the slider arrows to highlight a setting, then tap Select.



IMPORTANT: *You may need to keep sliding to see a complete list of available options.*

3 Follow the on-screen instructions. Tap Save to accept your selections.

4 Tap  (Back) to exit.

Settings menus

Setting	Options
Upgrade firmware This option is only displayed if the upgrade file (.img) is available on the frame (memory card, flash drive, internal memory, etc.).	Upgrade firmware —load the latest version of firmware on your frame (see page 62). Exit —return to the Home screen.



Setting	Options
<p>Viewing options</p>	<p>Sort—available during a slide show only (see page 36).</p> <p>Background music—available during a slide show only (see page 37).</p> <p>Slide duration—specify how long each picture is displayed in a slide show, from 3 seconds to 1 hour. (The default is 5 seconds.)</p> <p>Transitions—specify the transition style between pictures in a slide show. See screen for options. The default is Random.</p> <p>Shuffle—plays the images in random order.</p> <p>Slide show starting point—when pictures are sorted from oldest to newest (see page 36), specify where a slide show starts automatically (from picture dated 1 week back, or from oldest picture).</p> <p>Brightness—slide to adjust the screen brightness according to your lighting conditions.</p> <p>Frame orientation—display your frame in landscape (default) <input type="checkbox"/> or portrait <input type="checkbox"/> orientation.</p> <p>Screen Fit or Fill—</p> <p>Fit entire image  (default). Show the entire picture. Black borders may appear around the image.</p> <p>Fill the screen . The picture fills the entire screen; some of the picture may be cut off (cropped).</p> <p>Music auto-play—choose to play music automatically during a slide show. (Music files must be in the same location as your pictures.)</p> <p>Audio priority—when you are playing music (see page 37), choose whether or not to play the audio portion of a video.</p> <p>Play music (default). Music continues to play, video plays but its audio is muted. Play video soundtrack. Music stops playing while the video, with audio, plays.</p>

Setting	Options
Clock and timer	On/Off schedule —set your frame to turn on and off at a specified time every day (see page 61). Set time —manually set the clock to the current time (see page 60).
KODAK Gallery	Specify your country, email address, and password. First, install the software (see page 9) and set up access to the KODAK Gallery (see page 12).
Network	Set up your frame for wireless operation. See page 5 .
Device configuration	Frame name —use the on-screen keyboard to assign a name to your frame. This name is referenced when connecting to your wireless network. If you have more than one frame on your wireless network, give them unique names so you can tell them apart. RSS feeds —simple sites you set up to view on your frame using the Digital Display Software. Edit RSS feeds from your computer using the software. See page 26 . Frame connections —choose how your frame works with other devices. Share frame content: choose to turn off or allow devices (such as computers or other wireless frames) to access your frame contents; Remote setup: specify whether or not to allow your frame to be set up from your computer; Remote copy: turn off or allow copying to your frame from your computer; Remote copy destination: specify a default destination on your frame (internal memory, SD card, etc.) to save your copied pictures. USB connection mode —before you connect a USB computer or printer, choose Connect to computer (default) or Connect to printer . See page 40 .
Language	Choose your language (see page 4).



Setting	Options
Automatic resizing	Choose to turn on or off automatic resizing of your pictures when copying. Full resolution is unnecessary for viewing and quickly fills up the frame's memory. Choose full resolution for printing.
About	Check your frame model, serial number, and firmware version.

Setting the clock and timer

Manually setting the clock

- 1 Tap  (Home), then  (Settings).
- 2 Highlight Clock and timer, then tap Select.
- 3 Highlight Set time, then tap Select.
- 4 Slide to set the hour. Tap the Next arrow to highlight the next setting (minutes), then slide to adjust it.
- 5 Tap Save to accept your changes.



Getting the time from the Internet

- 1 Make sure your frame and computer are connected to your wireless network (see [page 5](#)) and your computer is connected to the Internet.
- 2 On your frame, tap  (Home), then  (Settings).
- 3 Highlight Clock and timer, then tap Select.
- 4 Highlight Get time from Internet, then tap Select.
- 5 Highlight Turn on, then tap Select.
- 6 Highlight a Time Zone, then tap Save to accept your changes.

Setting automatic on/off

Set your frame to turn on and off at a specified time every day.

NOTE: Set the clock before enabling auto on/off.

- 1 Tap  (Home), then  (Settings).
- 2 Highlight Clock and timer, then tap Select.
- 3 Highlight On/Off schedule, then tap Select.

The current time is displayed and the hour field is highlighted.

- 4 Set the Turn on time. Slide to adjust the hour. Tap the Next arrow to highlight the next setting (minutes), then slide to adjust it. Repeat to set Turn off time.

NOTE: Make sure the on time is earlier than the off time or the frame turns off itself at unspecified times.

- 5 Tap Enable, then Save when you're done.

Your frame will now automatically turn on and off at the times you specified.



If your frame loses power, the clock time returns to the factory setting and the automatic on/off times, if set, are disabled. To reset the clock and re-enable your on/off times, see [Resetting the clock after losing power, page 70](#).

Upgrading your software and firmware

Upgrade to the latest versions of the software included on the CD that was packaged with your frame (see [page 9](#)). Firmware is the software that runs on your frame. To check for the latest version, visit www.kodak.com/go/digitalframedownloads.

Manually upgrade firmware

Download the firmware to your computer, then upgrade your frame:

- 1 On your computer, go to www.kodak.com/go/digitalframedownloads.
- 2 Follow the screen directions to download the frame firmware to your computer.
- 3 Copy the IMG file to the top level folder (root directory) of a memory card or USB flash drive, then insert into the frame. See [page 41](#) for copying files.
- 4 Tap  (Home), then  (Settings).
- 5 Highlight Firmware Upgrade, then tap OK to begin the upgrade.

IMPORTANT: *Do not turn off the frame or remove the memory card or USB flash drive during the upgrade!*

When the upgrade is complete, your frame automatically restarts. If it doesn't, press the power button on the frame to Off, then back to On.

Automatically upgrade firmware from the Internet

When the frame is connected to your wireless network, you can automatically upgrade the firmware from the Internet whenever a new version is available.

For the latest features and best experience with your frame, upgrade your firmware from the Internet whenever the new firmware upgrade message appears.

For more information about your frame's new features, explore the EASYSHARE Digital Display Software on your computer or in Web Media on your frame's Home screen (see [page 30](#)).

Upgrade right away

- **Install now**—Select, then press OK to start the upgrade.

When the upgrade is complete, your frame automatically restarts. If it doesn't, press the power switch on the frame to Off, then back to On.

IMPORTANT: *Do not turn off the frame during the upgrade!*

Upgrade later

- **Remind me later**—Select, then press OK.

The upgrade message disappears, then appears again the next time you turn on the frame.

- **No thanks**—Select, then press OK.

The upgrade message disappears. To change your mind and upgrade to this version, see [Manually upgrade firmware, page 62](#).

A new message appears when the next firmware version is available.

Adding a matte and faceplate

Customize your frame with a decorative matte and/or faceplate (packaged with some frames). Additional mattes and faceplates are available for purchase (see [page 66](#)).

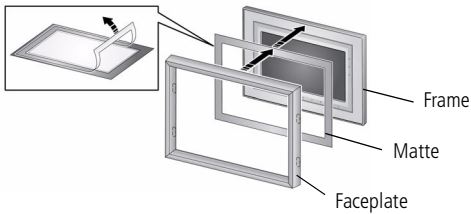

When you are not using the matte, reapply it to the liner and store in a plastic bag to keep the adhesive backing clean.

Mounting your frame on the wall

Use wall-anchoring hardware (not included) to anchor your frame securely to your wall.

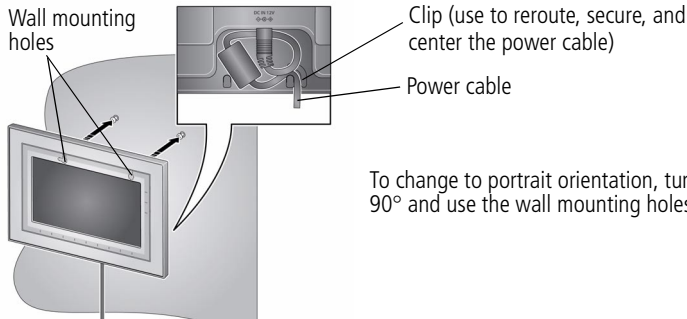

To change to portrait orientation, turn your frame 90° and use the wall mounting holes at the top.

Changing your frame orientation

Change the frame orientation setting if you change to portrait  orientation.

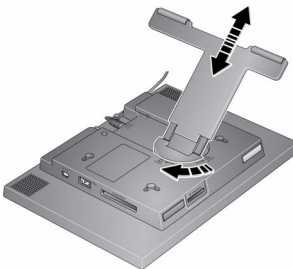





Change the stand position and angle:

- Rotate the stand 90 °, then pull it out or push it in to adjust the frame angle.

NOTE: When displayed with the stand extended, the frame rests at a 68-90 ° angle.

Change the frame orientation setting:

- 1 Tap  (Home) →  (Settings).
- 2 Slide to highlight  (Viewing options), then tap OK.
- 3 Slide to highlight Frame orientation, then tap OK.
- 4 Slide to highlight Portrait, then tap OK
- 5 Tap  to exit.

Your frame is set up now to display pictures in portrait  orientation.

Maintaining your frame and mattes

IMPORTANT: *Always disconnect the power before cleaning. Do not use water, cleaning solutions, or other adhesives on the frame or any of its parts.*

Gently wipe the frame, LCD, or matte with a clean, dry, lint-free cloth (included). For fingerprints on the frame, apply light pressure.

Learning more about your frame

www.kodak.com/go/digitalframes

Purchase frame accessories, including decorative faceplates and custom mattes

www.kodak.com/go/digitalframesupport

Extended user guide

Interactive troubleshooting and repairs

Interactive tutorials

Frequently asked questions

Downloads

Product registration

For step-by-step product support, visit www.kodak.com/go/digitalframesupport and select Interactive Troubleshooting & Repairs.

Frequently asked questions

I already have KODAK EASYSHARE Software on my computer. Do I have to install it again?

The CD that was packaged with your frame contains a special version of EASYSHARE Software that lets your computer share pictures with your frame. Install it to upgrade to this special software version, see [page 9](#).

I lost my Internet connection in the middle of my setup. What should I do?

Reconnect to the Internet and repeat the installation and setup, starting on [page 9](#).

I can't find my network. Why?



- Is your network set up to broadcast SSID? If so, you must enter your wireless network information manually. The person who set up your network can help you with this information.
- Does your network have security enabled (WEP or WPA)? ([See page 8.](#))

I can't find my network computer. Why?

- Make sure your router and your computer are on.
- Make sure your computer is on your wireless network. See the documentation that came with your router and your computer.
- Is your frame allowed to share content with your computer? See [page 12](#).

I didn't connect to my network the first time I turned on my frame. Can I do it now?

Yes, you can.

- 1 Tap Home  → Settings  . Slide to highlight Network, then tap Select.
- 2 Highlight Scan for wireless networks, then tap OK.
- 3 Continue with step 1 on [page 5](#).

Picture frame problems

If..	Try one or more of the following
Frame cannot connect to the wireless network —“Wireless network not found” appears.	<ul style="list-style-type: none"> ■ Make sure you have a wireless router and that it is broadcasting the SSID, or enter the SSID manually. ■ Make sure you are within the operating range of the network. Move the frame into the same room with the router. ■ Make sure your frame is using the latest firmware. Check www.kodak.com/go/digitalframesupport for updates. ■ If your network security is enabled (See page 8), enter your security key (WEP or WPA). The person who set up your network can help you with this information.
Frame does not turn on.	<ul style="list-style-type: none"> ■ Make sure the power cable that was included with your frame is connected securely (see page 2). ■ Unplug the power cable for 5 seconds, then reconnect the cable. Press and hold the power button (for about 2 seconds), then release.

If...	Try one or more of the following
<p>Nothing happens when a memory card, camera, or USB device is connected.</p>	<ul style="list-style-type: none"> ■ Insert a certified SD/MMC/MS/xD/CF/MD Card with images into the designated card slot, then push to seat it (see page 28). In the top card slot, make sure the card is seated flush with the top. ■ Make sure the USB cable that was included with your camera or USB device is connected securely (see page 29). ■ Make sure the file format of your pictures and videos are supported. (See page 73). <p>NOTE: Do not insert a SANDISK Memory Stick, PRO DUO Card or other micro or mini memory card without an adapter.</p> <p>NOTE: Pictures may take a longer time to display when: the picture/video files are large; when using a large capacity memory card or other connected device.</p>
<p>Touch border doesn't work.</p>	<ul style="list-style-type: none"> ■ Use your finger to make your selections on the touch-sensitive borders (see page 3). Lights on the border show you where to touch. <p>IMPORTANT: <i>Do not slide on the right border (tap only).</i></p> <ul style="list-style-type: none"> ■ Unplug the power cable for 5 seconds, then reconnect the cable. Press and hold the power button (for about 2 seconds), then release.
<p>Frame freezes up or doesn't work properly.</p>	<ul style="list-style-type: none"> ■ Unplug the power cable from the frame. Wait 5 seconds, then reconnect the cable. Press and hold the power button (for about 2 seconds), then release. ■ Press the Volume and Power buttons at the top of the frame (see page ii) at the same time, then tap Yes to reset the frame. (Resetting your frame does not erase your saved files.)
<p>Music doesn't play.</p>	<ul style="list-style-type: none"> ■ Make sure the volume is turned up (see page ii). ■ If your frame has songs you purchased, they may be protected files. Convert the files to standard (unprotected) AAC or MP3 formats.
<p>You set automatic on/off but the frame doesn't turn on and off at the specified times.</p>	<ul style="list-style-type: none"> ■ Make sure you Enabled the on/off setting after you set the times, then press OK (not Back). See page 61. ■ If your frame loses power, the clock returns to the factory setting and auto on/off times are disabled. See Resetting the clock after losing power, page 70.

Resetting the clock after losing power

If you turn off the power on the frame or otherwise lose power for half a day or more, the clock time returns to the factory setting and the automatic on/off times, if set, are disabled.

- When you turn the frame back on, the set time screen appears on the frame.
- Slide to set the hour. Tap the left/right arrows to highlight the previous or next setting (hour and minutes), then slide to adjust the setting.
- Tap OK.

The Home screen appears. The time is reset and the automatic on/off times (if set) are re-enabled. It is not necessary to reset the on/off times.

NOTE: If you exit the set time screen without setting the time, you can manually reset the clock and re-enable the automatic on/off times (see [page 61](#)). It is not necessary to reset the on/off times.

Picture frame/computer communications

If...	Try one or more of the following
Cannot copy pictures to my computer.	<ul style="list-style-type: none"> ■ Make sure your frame and computer are on. ■ Make sure to install the software that was packaged with your frame (see page 9) and copy pictures between your frame and computer using the EASYSHARE Digital Display Software (see page 53). ■ Make sure the power button on the frame is On (see page ii).
Cannot see my frame as a removable drive.	
Cannot copy pictures from KODAK EASYSHARE Software.	<ul style="list-style-type: none"> ■ Make sure your frame and computer are on. ■ Make sure to install the software that was packaged with your frame (see page 9). ■ From My Collection in EASYSHARE Software, make sure the pictures are in the Picture Tray.

If...	Try one or more of the following
<p>Cannot copy pictures from one device to another even though the copy destination is not full.</p>	<p>Storage devices that have FAT (File Allocation Table) 16 formatting can only store up to 512 files in its top level folder (root directory). To make sure all your pictures copy properly, format the copy destination to FAT32 before copying to it:</p> <p>Caution: Formatting deletes all pictures and videos, including protected files.</p> <ol style="list-style-type: none"> 1 Connect the device to your computer. 2 Open My Computer and locate the device. 3 Right-click on it and choose Format. 4 From the File system drop-down menu, choose FAT32 then click Start.

Screen messages

Screen message	Try one or more of the following
<p>Create file failed.</p>	<p>The device (memory card, USB drive, camera, etc.) you are trying to copy to is protected.</p> <ul style="list-style-type: none"> ■ See your device documentation to remove write protection. ■ Insert or connect a different device.
<p>Printer unavailable. Unable to connect to printer.</p>	<ul style="list-style-type: none"> ■ Make sure your printer is on and the USB cable is securely connected (see page 39). ■ Make sure you changed your USB connection mode from computer to printer (see page 40).
<p>Printing error.</p>	<ul style="list-style-type: none"> ■ Make sure your printer is on and the USB cable is securely connected (see page 39). ■ Check your printer for more info.
<p>Time out occurred while printing.</p>	<ul style="list-style-type: none"> ■ Check cables and printer supplies. Print again.

Screen message	Try one or more of the following
Write failed. Select another location.	The frame was unable to copy the picture. ■ Insert a different card or device (see page 28).
Unable to create file. Device write protected or full.	The frame was unable to copy the picture. ■ Insert a different card or device (see page 28).
Disk full.	■ Remove write protection, unlock card. ■ Delete pictures from card.
Error attempting to open file or directory.	■ Turn off the frame, then turn it back on. Press and hold the power button (for about 2 seconds), then release. If the problem persists, contact customer support help, at www.kodak.com/go/digitalframesupport .
Error duplicate filename.	
Error occurred while closing a file.	
Error invalid filename	
Error reading from file.	
Error writing from file.	
Error writing a file.	
Error writing to a file.	
File Copy Failed!	
Internal error.	
Parameter is invalid.	
Unknown error.	

Digital frame specifications

For more specifications, visit www.kodak.com/go/digitalframesupport.

KODAK EASYSHARE W820/W1020 Wireless Digital Frames	
Color display	
W820	20.3 cm (8 in.) diagonal digital LCD, 800 x 480 pixels, 4:3 or 16:9 aspect ratio, 17.6 x 10 cm (6.9 x 3.9 in.) viewable area
W1020	25.4 cm (10 in.) diagonal digital LCD, 800 x 480 pixels, 16:9 aspect ratio, 23.5 x 14.6 cm (9.3 x 5.8 in.) viewable area
Internal storage capacity	
W820, W1020	512 MB
Power	
Leader Electronics Inc. AC adapter, model MU18-2120150-A1, 12-volt, 1.5 amp. Europe: Pihong AC adapter, model PSA 18R-120P (See page 75 for more information.)	
Communication with computer	
USB 1.0 cable	
Wi-Fi wireless network compatibility	
W820, W1020	Yes
Other features	
PICTBRIDGE Support	Yes

KODAK EASYSHARE W820/W1020 Wireless Digital Frames	
Picture formats	JPEG, JPG, EXIF 2.2
Video formats	MOV, AVI, MPG, MPEG NOTE: HD (High Definition) is not supported on your frame. Video formats created with digital cameras are certified for KODAK Digital Frames. Videos created with or copied from other sources may not play on your frame.
Music format	MP3
Memory cards	MMC (MULTIMEDIA Card); SD/SDHC (SECURE DIGITAL/SECURE DIGITAL HIGH CAPACITY); MEMORY STICK, xD; CF; MD
Tripod mount	1/4 inch
Temperature	Operating: 32 to 122°F (0 to 50°C) Storage: -4 to 140°F (-20 to 60°C)
Size	W820: 28.5 x 21 x 3.8 cm (11.2 x 8.3 x 1.5 in.) W1020: 33 x 24 x 3.8 cm (13 x 9.5 x 1.5 in.)

Important safety instructions



CAUTION:

Do not disassemble this product; there are no user-serviceable parts inside. Refer servicing to qualified service personnel. Do not expose this product to liquid, moisture, or extreme temperatures. The use of controls, adjustments, or procedures other than those specified herein may result in exposure to shock and/or electrical or mechanical hazards. If the LCD breaks, do not touch the glass or liquid. Contact Kodak customer support.



CAUTION:

When using this product, it should be installed and operated with a minimum distance of 7.9 in. (20 cm) for 2.4 GHz operations between the radiator and your body. This transmitter must not be collocated or operate in conjunction with any other antenna or transmitter.

- The use of an accessory that is not recommended by Kodak may cause fire, electric shock, or injury. For approved accessories, visit www.kodak/go/accessories.
- Use only a Leader Electronics Inc. AC adapter, model MU18-2120150-A1, 12-volt, 1.5 amp.
In Europe, use only a Pihong AC adapter, model PSA 18R-120P.
Use of other AC adapters may damage the frame and void your warranties.
- Use only a USB-certified computer equipped with a current-limiting motherboard. Contact your computer manufacturer if you have questions.
- When displayed with the stand extended, the frame rests at a 68 - 90 degree angle.
- Do not place frame near naked flame sources such as lighted candles or heaters.
- Excessive sound pressure from earphones and headphones may cause hearing loss.

Additional care and maintenance

- Wipe the frame and the LCD gently with a soft, lint-free cloth (included). Do not use cleaning solutions unless designed specifically for LCD screens. Do not allow chemicals, such as suntan lotion, to contact painted surfaces.
- Service agreements are available in some countries. Contact a dealer of Kodak products for more information.
- For digital frame disposal or recycling information, contact your local authorities. In the US, visit the Electronics Industry Alliance Web site at www.eiae.org or visit www.kodak.com/go/digitalframesupport.

Limited warranty

Kodak warrants Kodak consumer electronic products and accessories ("Products"), excluding batteries, to be free from malfunctions and defects in both materials and workmanship for one year from the date of purchase. Retain the original dated sales receipt. Proof of the date of purchase will be required with any request for warranty repair.

Limited warranty coverage

Warranty service is only available from within the country where the Products were originally purchased. You may be required to ship Products, at your expense, to the authorized service facility for the country where the Products were purchased. Kodak will repair or replace Products if they fail to function properly during the warranty period, subject to any conditions and/or limitations stated herein. Warranty service will include all labor as well as any necessary adjustments and/or replacement parts. If Kodak is unable to repair or replace a Product, Kodak will, at its option, refund the purchase price paid for the Product provided the Product has been returned to Kodak along with proof of the purchase price paid. Repair, replacement, or refund of the purchase price are the sole remedies under the warranty. If replacement parts are used in making repairs, those parts may be remanufactured, or may contain remanufactured materials. If it is necessary to replace the entire Product, it may be replaced with a remanufactured Product. Remanufactured Products, parts and

materials are warranted for the remaining warranty term of the original Product, or 90 days after the date of repair or replacement, whichever is longer.

Limitations

This warranty does not cover circumstances beyond Kodak's control. This warranty does not apply when failure is due to shipping damage, accident, alteration, modification, unauthorized service, misuse, abuse, use with incompatible accessories or attachments (such as third party ink or ink tanks), failure to follow Kodak 's operation, maintenance or repacking instructions, failure to use items supplied by Kodak (such as adapters and cables), or claims made after the duration of this warranty. Kodak makes no other express or implied warranty for this product, and disclaims the implied warranties of merchantability and fitness for a particular purpose. In the event that the exclusion of any implied warranty is ineffective under the law, the duration of the implied warranty will be one year from the purchase date or such longer period as required by law. The option of repair, replacement, or refund is Kodak's only obligation. Kodak will not be responsible for any special, consequential or incidental damages resulting from the sale, purchase, or use of this product regardless of the cause. Liability for any special, consequential or incidental damages (including but not limited to loss of revenue or profit, downtime costs, loss of the use of the equipment, cost of substitute equipment, facilities or services, or claims of your customers for such damages resulting from the purchase use or failure of the Product), regardless of cause or for breach of any written or implied warranty is expressly disclaimed.

Your rights

Some states or jurisdictions do not allow exclusion or limitation of incidental or consequential damages, so the above limitation or exclusion may not apply to you. Some states or jurisdictions do not allow limitations on how long an implied warranty lasts, so the above limitation may not apply to you. This warranty gives you specific rights, and you may have other rights which vary from state to state or by jurisdiction.

Outside the United States and Canada

In countries other than the United States and Canada, the terms and conditions of this warranty may be different. Unless a specific Kodak warranty is communicated to the purchaser in writing by a Kodak company, no warranty or liability exists beyond any minimum requirements imposed by law, even though defect, damage, or loss may be by negligence or other act.

Regulatory compliance

FCC compliance and advisory

 KODAK EASYSHARE W820/W1020 Wireless Digital Frames
--

This equipment has been tested and found to comply with the limits for a Class B digital device, pursuant to Part 15 of the FCC Rules. These limits are designed to provide reasonable protection against harmful interference in a residential installation.

This equipment generates, uses, and can radiate radio frequency energy and, if not installed or used in accordance with the instructions, may cause harmful interference to radio communications. However, there is no guarantee that interference will not occur in a particular installation.

If this equipment does cause harmful interference to radio or television reception, which can be determined by turning the equipment off and on, the user is encouraged to try to correct the interference by one or more of the following measures: 1) reorient

or relocate the receiving antenna; 2) increase the separation between the equipment and the receiver; 3) connect the equipment to an outlet on a circuit different from that to which the receiver is connected; 4) consult the dealer or an experienced radio/TV technician for additional suggestions.

Any changes or modifications not expressly approved by the party responsible for compliance could void the user's authority to operate the equipment. Where shielded interface cables have been provided with the product or specified additional components or accessories elsewhere defined to be used with the installation of the product, they must be used in order to ensure compliance with FCC regulation.

FCC and Industry Canada

This device complies with Industry Canada RSS-210 and FCC Rules. Operation is subject to the following two conditions: (1) this device may not cause harmful interference, and (2) this device must accept any interference received, including interference that may cause undesired operation.

FCC et Industrie Canada

Cet appareil est conforme à la norme RSS-210 d'Industrie Canada et aux réglementations de la FCC. Son utilisation est soumise aux deux conditions suivantes : (1) cet appareil ne doit pas provoquer d'interférences nuisables, et (2) cet appareil doit supporter les interférences reçues, y compris celles susceptibles de nuire à son bon fonctionnement.

Canadian DOC statement

DOC Class B Compliance—This Class B digital apparatus complies with Canadian ICES-003.

Observation des normes-Classe B—Cet appareil numérique de la classe B est conforme à la norme NMB-003 du Canada.



CE 1588		!		R&TTE Directive 1999/5/EC					
BE	✓	DK	✓	GR	✓	ES	✓	FR	✓
IE	✓	IT	✓	LU	✓	NL	✓	AT	✓
PT	✓	FI	✓	SE	✓	UK	✓	NO	✓
DE	✓	BG	✓	PL	✓	HU	✓	SK	✓
CZ	✓	EE	✓	RO	✓	CY	✓	LT	✓
LV	✓	MT	✓	SL	✓				

Hereby, Eastman Kodak Company declares that this Kodak product is in compliance with the essential requirements and other relevant provisions of Directive 1999/5/EC. This digital picture frame (W820 or W1020) transmits in 10 dBm. In France, the power level is limited to 10dBm in outdoor environments, per regulations. When in France, use the wireless functions of this device indoors only.

Waste Electrical and Electronic Equipment labeling



EU: It is the final user's responsibility to discard this equipment into an approved, segregated collection scheme to enable its suitable treatment/disposal and to improve human/environmental protection. For more information, see your retailer, local authority, or www.kodak.com/go/recycle.

Australian C-Tick



N137

MPEG-4

Use of this product in any manner that complies with the MPEG-4 visual standard is prohibited, except for use by a consumer engaging in personal and non-commercial activities.

Russian GOST-R



Eastman Kodak Company
Rochester, New York 14650

Цифровая фоторамка изготовлена в Китае; остальные элементы – в соответствии с маркировкой

China RoHS

环保使用期限 (EPUP)

在中国大陆，该值表示产品中存在的任何危险物质不得释放，以免危及人身健康、财产或环境的时间期限（以年计）。该值根据操作说明中所规定的产品正常使用而定。

Environmental Protection Use Period (EPUP)

In China, this number indicates the time period (in years) within which any hazardous substances present in the product are not expected to be released such that there is risk to human health, property, or the environment. This value is assigned based on normal use of the product as described in the operating instructions.

Product Disclosure Table

有毒有害物质或元素名称及含量标识表
table of hazardous substances' name and concentration

部件名称 Component name	有毒有害物质或元素 hazardous substances' name					
	铅 (Pb)	汞 (Hg)	镉 (Cd)	六价铬 (Cr6+)	多溴联苯 (PBB)	多溴二苯 醚 (PBDE)
数码相架电路板元件 (Digital Photo Frame circuit board components)	X	O	O	O	O	O
控制器 (Controller)	X	O	O	O	O	O
交流变压器电路板元件 (AC Adapter circuit board components)	X	O	O	O	O	O

O: 表示该有毒有害物质在该部件所有均质材料中的含量均在SJ/T 11363-2006规定的限量要求以下。

X: 表示该有毒有害物质至少在该部件的某一均质材料中的含量超出SJ/T 11363-2006规定的限量要求。

O: indicates hazardous substance concentration lower than MCV

X: indicates hazardous substance concentration higher than MCV



USB 数据线

Korean Class B ITE

이 기기는 가정용으로 전자파적합등록을 한 기기로서 주거지역에서는 물론 모든 지역에서 사용할 수 있습니다.

Licensing

Supply of this product does not convey a license nor imply any right to distribute content created with this product in revenue-generating broadcast systems (terrestrial, satellite, cable and/or other distribution channels), streaming applications (via Internet, intranets and/or other networks), other content distribution systems (pay-audio or audio-on-demand applications and the like) or on physical media (compact discs, digital versatile discs, semiconductor chips, hard drives, memory cards and the like). An independent license for such use is required. For details, please visit <http://mp3licensing.com>.

Notice

When this digital frame is connected to a wireless network, it is possible to view images and other content directly from the Internet.

Eastman Kodak Company, its subsidiaries and affiliates do not control and are not responsible for any content displayed or viewed.

Index

A

- about, frame, 60
- appendix, 73
- automatic on/off, 59, 61

B

- battery
 - safety, 75
- button
 - macro/landscape, ii

C

- cables
 - USB, connecting, 29
- camera, connecting, 29
- changing picture locations, 32
- clock and timer, setting, 59, 60, 61
- computer
 - copying to/from, 53
 - help with communicating, 70
- connection mode, 40
- copying
 - from EASYSHARE Software, 55
 - to/from computer, USB, 53

D

- deleting pictures and videos, 42
- displaying slide show, 35
- disposal, recycling, 76
- doing more with your frame, 37

E

- EASYSHARE Software
 - copying pictures from, 55
- error messages, 71

F

- fast forward video, 38
- firmware
 - checking version, 60
 - upgrading, 57
- flash drive, connecting, 29
- frame, picture
 - changing orientation, 1
 - checking model, firmware, serial number, 60
 - setup, 1
 - specifications, 73
 - troubleshooting, 68

H

- help
 - communicating with computer, 70
 - frame, 68
- home
 - changing picture locations, 32
 - screen, 32

I

- internal memory
 - capacity, 73
- internet
 - requirements for wireless, 44

L

landscape, set orientation, 58

language

setting, 59, 60

setting first time, 4

M

MAC OS users, 15

macro/landscape button, ii

multi-up view, 33

O

on/off, setting auto, 59, 61

orientation setting, 1, 58

P

PICTBRIDGE enabled Printer, 39

pictures

copying connected, 53

copying from EASYSHARE
Software, 55

deleting, 42

location, changing, 32

selecting more than one, 43

play/pause, video, 38

portrait, set orientation, 58

power

specifications, 73

printer connection mode, 40

printing, PICTBRIDGE Printer, 39

R

recycling, disposal, 76

regulatory compliance, 78

rewind video, 38

running slide show, 35

S

safety information, 75

screen

cleaning, 76

error messages, 71

selecting multiple pictures, 43

serial number, checking, 60

setting

auto on/off, 59, 61

language, 59, 60

language first time, 4

time, 59

viewing options, 58

wireless operation, 44

setup

picture frame, 1

wireless network, 44

slide duration, setting, 58

slide show

running, 35

slide transitions, setting, 58

source, picture location, 32

specifications, frame, 73

stop

video, 38

storage capacity, internal memory, 73

T

thumb drive. See flash drive., 29

thumbnails, 33

time, setting, 59

transitions, slides, setting, 58

troubleshooting
 error messages, 71
 frame, 68

U

upgrading
 firmware, 57
USB connection mode, 40
USB device, connecting, 29

V

viewing
 pictures, wireless network, 45
 thumbnails, 33

W

warranty, 76
wireless
 features on frame, overview, 44
 setup, 44
 viewing pictures, 45