

Kodak
KE40
35 mm
Camera



This device complies with part 15 of the FCC Rules. Operation is subject to the following two conditions: (1) This device may not cause harmful interference, and (2) this device must accept any interference received, including interference that may cause undesired operation.

NOTE: Your model camera has been tested and found to comply with the limits for a Class B digital device, pursuant to Part 15 of the FCC Rules. These limits provide reasonable protection against interference in residential use. The camera generates, uses and can radiate radio frequency energy and, if not used in accordance with the instructions, may cause interference to radio communications. There is no guarantee that interference will not occur. If this camera does cause interference to radio or television reception, which can be determined by turning the camera off and on, you may reduce the interference by the following:

- Reorient or relocate the receiving antenna.
- Increase the separation between the camera and the receiver.
- Consult the dealer or an experienced radio/television technician for help.

Changes or modifications not approved by the party responsible for compliance could void the user's authority to operate the equipment.

This Class B digital apparatus meets all requirements of the Canadian Interference-Causing Equipment Regulations.

Getting to Know Your Camera

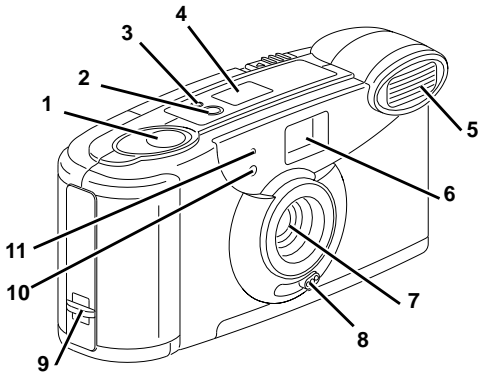

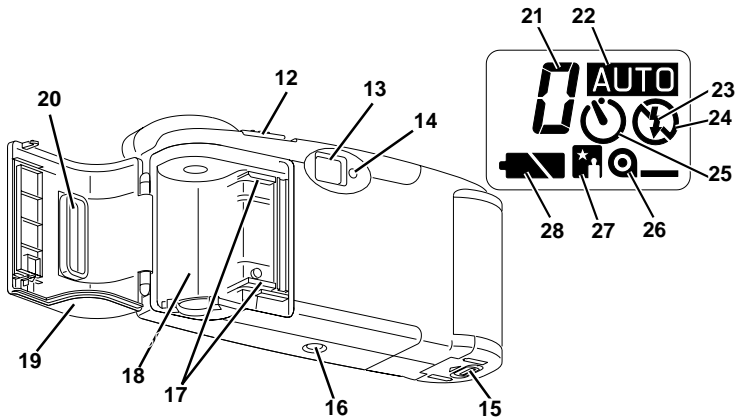

Contents

Need Help with Your Camera?	6
Camera Identification	7
Specifications	8
Attaching the Camera Strap	9
Loading the Batteries	9
Loading the Film	11
Taking Pictures	13
Taking Flash Pictures	16
Selecting the Flash Modes and Self-timer	17
Unloading the Film	22
Troubleshooting	23
For Owners of the Quartz Date Back Model	25

Need Help with Your Camera?

Call:

Kodak (USA only) toll free from 9:00 a.m. to 7:00 p.m. (Eastern time) Monday through Friday at 1 (800) 242-2424.

Kodak (Canada only) from 8:30 a.m. to 5:00 p.m. (Eastern time) Monday through Friday at 1 (800) 465-6325, ext. 36100; for the Toronto area, call (416) 766-8233, ext. 36100.

Visit our web site at <http://www.kodak.com>

For warranty purposes, please keep your sales receipt as proof of the date of purchase.

© Eastman Kodak Company, 1997

Camera Identification (see inside front cover for diagrams)

- | | |
|---|-----------------------------------|
| 1 Shutter Button | 16 Tripod Socket |
| 2 Mode-Selector Button | 17 Film-Guide Rails |
| 3 Film-Rewind Button | 18 Film Chamber |
| 4 LCD Panel | 19 Film Door |
| 5 Flash | 20 Film Window |
| 6 Viewfinder | |
| 7 Lens | <i>LCD Panel</i> |
| 8 Lens-Cover Switch | 21 Frame Counter |
| 9 Strap Post | 22 Auto-Flash Symbol |
| 10 Self-Timer/Red-Eye-Reduction Lamp | 23 Fill-Flash Symbol |
| 11 Flash Sensor | 24 Flash-Off Symbol |
| 12 Film-Door Latch | 25 Self-Timer Symbol |
| 13 Viewfinder Eyepiece | 26 Film-Presence Indicator |
| 14 Flash-Ready Light | 27 Nighttime-View Symbol |
| 15 Battery-Door Latch | 28 Battery Symbol |

Specifications

Type:	35 mm fixed-focus, easy-load camera
Lens:	29 mm, <i>f</i> /5.6 hybrid
Flash Unit:	KODAK SENSALITE™ Flash with automatic power down to conserve battery power
Viewfinder:	Reverse-Galilean
Aperture:	<i>f</i> /5.6
Shutter Speed:	Programmed
Film Speed:	DX (ISO) 100, 200, or 400 print film
Focus Range:	Daylight: 4 ft (1.2 m) to infinity
Power Source:	2 AA-size alkaline batteries
Dimensions:	5.4 x 2.7 x 1.7 in (136.3 x 68.7 x 44 mm)
Weight:	Approx. 6.5 oz (185 g)

Attaching the Camera Strap

Thread the short loop of the strap under the STRAP POST (9). Put the long loop through the short loop and pull it tight.

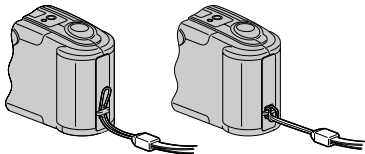

Loading the Batteries

This camera uses 2 AA-size alkaline batteries.

1. Slide the BATTERY-DOOR LATCH (15) in the direction of the arrow and lift up to open the door.
2. Load the batteries in the battery chamber.
3. Snap the battery door closed.

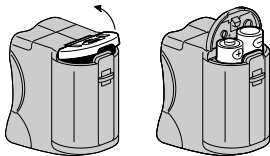

Low-Battery Indicator

It's time to replace the batteries when—

- the BATTERY SYMBOL **(28)** “blinks” on the LCD PANEL **(4)** *or*
- the camera repeatedly fails to take a picture *or*
- the FLASH-READY LIGHT **(14)** flashes longer than 15 seconds.

Auto Power Off

This camera automatically turns off after approximately 3 minutes to conserve battery power. To awake the camera, press the shutter button partway down.

Battery Tips

- Remember to keep spare batteries with you at all times.
- Read and follow all warnings and instructions supplied by the battery manufacturer.
- Keep batteries away from children.
- Do not try to take apart, recharge or short circuit the batteries, or subject them to high temperature or fire.
- Store batteries in their original packaging prior to use.

Loading the Film

If in sunlight, turn your back to the sun and load the film in the shade of your body.

1. Slide the **FILM-DOOR LATCH (12)** in the direction of the arrow to open the **FILM DOOR (19)**.

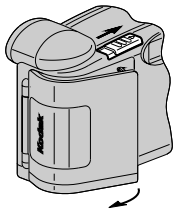

2. Insert the film leader into the slot in the back of the camera between the **FILM-GUIDE RAILS (17)**.

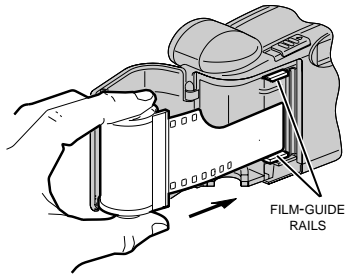

3. Push the film cartridge down into the FILM CHAMBER (18) until it fits securely into place. **Do not force it into the film chamber.**

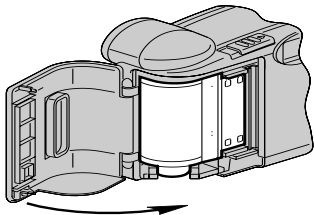

4. Close the film door to start the auto-film advance. The LCD PANEL (4) will show the first exposure, and you will see the film information in the FILM WINDOW (20). **When you close the safety-interlock film door, you cannot open the film door until the film is completely rewound into the film cartridge.**

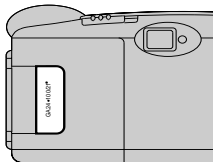

5. Slide the LENS-COVER SWITCH (8) completely open to uncover the LENS (7) and to turn the camera on.

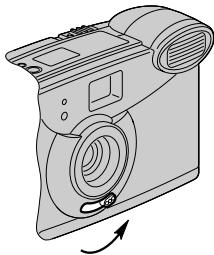

Taking Pictures

1. Slide the LENS-COVER SWITCH (8) completely open to uncover the LENS (7) and to turn the camera on.

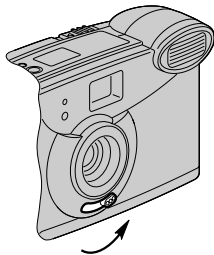

2. For a sharp picture stand at least 4 ft (1.2 m) from your subject.

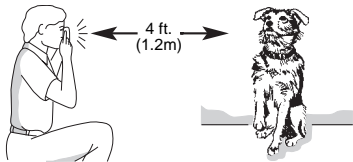

3. Look through the VIEWFINDER EYEPIECE (13) to see your subject.



4. Hold the camera steady and gently press the SHUTTER BUTTON (1) to take the picture. After you take the picture, the film automatically advances to the next picture. **Be careful not to cover the flash and picture-taking lens with your fingers.**

5. Close the lens cover when you are done taking pictures.

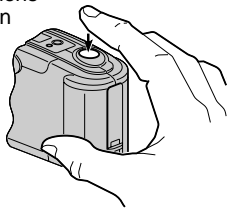

Tips for Better Pictures

- Keep your pictures simple. Move close enough to your subject so it fills the viewfinder **but not closer than 4 ft (1.2 m)**.
 - Take pictures at the subject's level. Kneel down to take pictures of children and pets.
 - Hold your camera vertically to capture tall, narrow subjects, such as a waterfall, skyscraper, or a single person.
- Add interest to your picture by framing it with a tree branch, a window, or even the rails of a fence.
 - Keep the sun behind you. This provides the best subject illumination.

Taking Flash Pictures

In dim light, such as indoors or outdoors in heavy shade or on dark overcast days, you need flash. Your camera features an automatic flash that fires when you need it.

1. Slide the LENS-COVER SWITCH (8) completely open to uncover the LENS (7) and to turn the camera on.

2. Take the picture when the “blinking” FLASH-READY LIGHT (14) disappears.

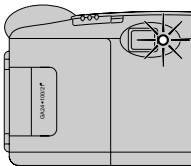

3. Keep the subject within the distance range for the speed of film in your camera. Don't take pictures beyond the maximum distance or your pictures will be dark.

ISO Film Speed	Flash-to-Subject Distance
100	4 to 9 ft (1.2 to 2.8 m)
200	4 to 13 ft (1.2 to 4.0 m)
400	4 to 18 ft (1.2 to 5.5 m)

4. Hold the camera steady and gently press the SHUTTER BUTTON (1) to take the picture. **Be careful not to cover the flash and picture-taking lens with your fingers.**

Selecting the Flash Modes and Self-timer

Besides the auto-flash mode, you can select manual fill flash, flash off, auto-flash with self-timer, nighttime-view with flash, or nighttime-view with flash off.

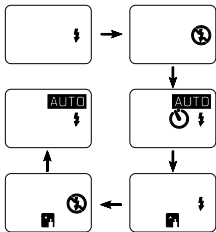

Press the MODE-SELECTOR BUTTON (2) until the desired indicator appears on the LCD PANEL (4).

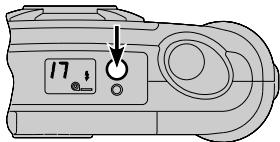

Only the manual fill-flash and flash-off modes will remain selected after you take the picture. To cancel these selections, turn the camera off or press the mode-selector button to return to the auto-flash start position.

Manual Fill Flash

Bright light indoors or outdoors from backlit subjects can create dark shadows (especially on faces) in high-contrast scenes. Use the fill-flash feature to lighten these shadows.

1. Press the **MODE-SELECTOR BUTTON (2)** until the manual fill-flash symbol appears on the **LCD PANEL (4)**.
2. Press the **SHUTTER BUTTON (1)** to take the picture. After you take the picture, the fill-flash symbol will blink for a few seconds and stop.

Flash Off

When you do not want to use the flash, especially indoors where flash is prohibited, such as in theaters and museums, or in dim lighting situations, use the flash-off feature. Use a tripod or place the camera on another firm support because the shutter speed will most likely be slow, and use ISO 400-speed film.

1. Press the **MODE-SELECTOR BUTTON (2)** until the flash-off symbol appears on the **LCD PANEL (4)**.
2. Press the **SHUTTER BUTTON (1)** to take the picture.

Nighttime-View Mode with Flash



In this mode, the camera balances the flash and existing light exposure so you can take beautiful pictures of people at sunset or at night. Use a tripod or place the camera on another firm support because the shutter speed will most likely be slow, and use ISO 400-speed film.

1. Press the **MODE-SELECTOR BUTTON (2)** until the nighttime-view with flash symbol appears on the **LCD PANEL (4)**.

2. Press and **hold** the **SHUTTER BUTTON (1)** for 12 seconds **without lifting your finger.**

NOTE: If you remove your finger from the shutter button before 12 seconds, the shutter will time out immediately.

3. Release the shutter button after 12 seconds to take the picture.

Nighttime-View Mode  
without Flash

In this mode, you can capture the natural existing light of city-night scenes or fireworks at night. Use a tripod or place the camera on another firm support because the shutter speed will most likely be slow, and use ISO 400-speed film.

1. Press the MODE-SELECTOR BUTTON **(2)** until the nighttime-view without flash symbol appears on the LCD PANEL **(4)**.

2. Press and **hold** the SHUTTER BUTTON **(1)** for 12 seconds **without lifting your finger.**

NOTE: If you remove your finger from the shutter button before 12 seconds, the shutter will time out immediately.

3. Release the shutter button after 12 seconds to take the picture.

***Self-Timer with
Auto Flash***



Use this feature to include yourself in pictures. The electronic self-timer will delay the release of the shutter button for approximately 10 seconds after you press the shutter button. The flash will automatically fire if required. To cancel the self-timer feature before the picture is taken, close the camera lens cover.

1. Place the camera on a tripod (TRIPOD SOCKET **[16]**).
2. Press the MODE-SELECTOR BUTTON **(2)** until the self-timer symbol appears on the LCD PANEL **(4)**.

3. Frame your subject within the VIEWFINDER EYEPIECE **(13)**.
4. Press the SHUTTER BUTTON **(1)** completely down.

Unloading the Film

The camera automatically rewinds the film into the film cartridge after the last exposure. Wait for the motor to stop running before you open the film door. The FILM PRESENCE INDICATOR **(26)** on the LCD PANEL **(4)** will blink until you remove the film from the camera.

Using Mid-Roll Rewind

If you don't want to take pictures on the entire roll of film, you can rewind the film manually by pressing the FILM-REWIND BUTTON **(3)** with a pointed object. The camera automatically rewinds the film into

the film cartridge. Wait for the motor to stop running before you open the film door. The FILM PRESENCE INDICATOR **(26)** on the LCD PANEL **(4)** will blink until you remove the film from the camera.

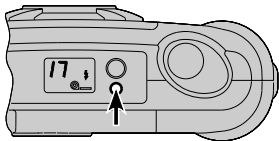

NOTE: You cannot reload partially exposed film into this camera for continuous picture-taking.

Troubleshooting

What happened	Probable cause	Solution
Camera will not operate	Lens cover closed	Open the lens cover completely
	Batteries improperly loaded in camera	Insert batteries as shown on battery door
	Flash not ready	Wait for the blinking flash-ready light to disappear
	Film needs to be rewound/removed	See Unloading the Film
Film does not advance or rewind	Batteries weak, dead, missing, or improperly inserted	Replace or reload batteries as shown on battery door

What happened	Probable cause	Solution
Shutter button cannot be released	No film in camera	Load film into the camera
	Lens cover closed	Open the lens cover completely
Film-door latch does not open	Film is not rewound into the cartridge completely	Complete taking pictures or press the film-rewind button
LCD panel is blank	Batteries weak, dead, missing, or improperly inserted	Replace or reload batteries as shown on battery door

For Owners of the Quartz Date Back Model

Date Back Model

Setting the Date and Time

The date and time feature enables you to record the date in a choice of three formats, (month/day/year, day/month/year, or year/month/day) or the time (day/hour/minute) directly onto the film.

Date and Time Imprinting

Press the Mode Button **(a)** to select the desired data type, then take the picture. Following the exposure, the Print Indicator **(d)** blinks in the data panel for approximately two-to-three seconds to confirm imprinting.

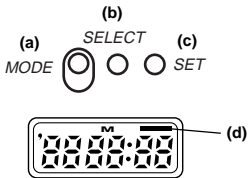

Mode Selection

Use the Mode Button **(a)** to change the data display as shown.

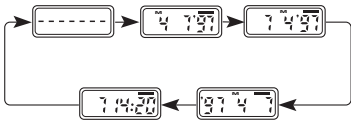

Setting Data

1. Press the Mode Button **(a)** to select the desired data type.
2. Use the Select Button **(b)** to move between different parts of the displayed data. With the data displayed, pressing the select button in succession causes the settings for year, month, and then day to blink.

In time mode, pressing the select button successively causes the hour, minute, and then the colon to blink.

3. Press the Set Button **(c)** to change the blinking display.

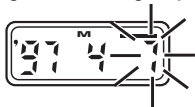

Replacing the Date Back Battery

The date back is powered by the main camera battery (see **Loading the Batteries**). After you replace the batteries, you will need to reset the date-back information.

Date back subject to minor appearance and specification changes.



Consumer Imaging
EASTMAN KODAK COMPANY
Rochester, NY 14650

© Eastman Kodak Company, 1997

Pt. No. **916 8261**

Kodak and Sensalite are trademarks.

5-97
Printed in U.S.A.